

## DOCUMENT RESUME

ED 353 355

UD 029 019

AUTHOR Knapp, Michael S.; And Others  
TITLE Academic Challenge for the Children of Poverty. Study of Academic Instruction for Disadvantaged Students. Summary Report.

INSTITUTION Policy Studies Associates, Inc., Washington, DC.; SRI International, Menlo Park, Calif.

SPONS AGENCY Office of Policy and Planning (ED), Washington, DC.

PUB DATE 92

CONTRACT LC88054001

NOTE 53p.

AVAILABLE FROM U.S. Department of Education, Office of Policy and Planning (Planning and Evaluation Service), Room 3127, 400 Maryland Ave., S.W., Washington, DC 20202.

PUB TYPE Reports - Evaluative/Feasibility (142)

EDRS PRICE MF01/PC03 Plus Postage.

DESCRIPTORS \*Academic Achievement; Basic Skills; Children; Curriculum Evaluation; \*Disadvantaged Youth; \*Economically Disadvantaged; Educational Environment; Elementary Education; \*Elementary School Students; \*Instructional Effectiveness; Instructional Innovation; \*Low Income Groups; Supplementary Education; Teacher Attitudes; Teaching Methods; Thinking Skills

IDENTIFIERS \*Meaning Emphasis Method

## ABSTRACT

This publication summarizes the findings of a 3-year study concerning the effectiveness of instruction that emphasizes meaning and understanding. In particular, the instructional approaches embedded the teaching of discrete skills in context and drew connections between academic learning and students' home lives. These strategies were applied in mathematics, reading, and writing instruction in 140 classrooms across 15 schools serving low-income students. The findings indicate that teachers most engaged in alternative practices were likely to have orderly classrooms in which various types of activities and interactions among students and teachers were encouraged. The use of standardized tests, writing samples, and tests of problem-solving proficiency produced evidence concerning the effects of these instructional practices on advanced skills and basic skills. Students exposed to instruction emphasizing meaning and understanding performed better on tests for advanced academic skills than did students not exposed to this type of instruction, even after initial differences in student achievement and poverty level were taken into consideration. The results also show that the proposed instructional strategies facilitate the mastery of basic skills or at least do not impede their mastery. Seventeen exhibits illustrate the findings. (JB)

ED353355

Study of Academic Instruction for Disadvantaged Students

# ACADEMIC CHALLENGE FOR THE CHILDREN OF POVERTY

Summary Report

1992

Prepared for the U.S. Department of Education under contract by

SRI International  
Menlo Park, CA  
and  
Policy Studies Associates  
Washington, DC

Contract No. IC 86051001

U.S. DEPARTMENT OF EDUCATION  
Office of Educational Research and Improvement  
EDUCATIONAL RESOURCES INFORMATION CENTER (ERIC)

This document has been reproduced as received from the person or organization originating it.

Minor changes have been made to improve reproduction quality.

• Points of view or opinions stated in this document do not necessarily represent official OERI position or policy.



U.S. DEPARTMENT OF EDUCATION • OFFICE OF POLICY AND PLANNING

**BEST COPY AVAILABLE**

This volume summarizes the final report of the Study of Academic Instruction for Disadvantaged Students, a 3-year investigation of curriculum and instruction in elementary schools serving high concentrations of children from low-income families. The study was carried out under contract with the U.S. Department of Education (Office of Policy and Planning) by SRI International in collaboration with Policy Studies Associates and with the assistance of the Educational Leadership and Policy Studies Area at the University of Washington.

In this summary report, we present the major findings and conclusions from all phases of the study. The summary report analyzes the outcomes of alternative approaches to instruction in the three subject areas. In addition, the final report subsumes and expands on descriptive findings regarding mathematics, reading, and writing instruction, originally presented in an interim report, *What Is Taught, and How, in Schools Serving the Children of Poverty* (March 1991).

A more detailed explanation of findings, conclusions, and study methods appears in two longer volumes, under the same title as this summary report:

*Volume 1: Findings and Conclusions*

*Volume 2: Study Design and Technical Notes*

The contents of these two volumes are outlined on the inside back cover of this summary report.

The investigation described here drew on a series of commissioned papers and other literature reviewed in the first report of the study, which is available in published form under the title *Better Schooling for the Children of Poverty: Alternatives to Conventional Wisdom* (Berkeley, CA: McCutchan, 1991).

The conduct of this study and the preparation of this report were sponsored by the U. S. Department of Education, Office of Policy and Planning (Planning and Evaluation Service), under contract No. LC88054001 (Project Officer: A. de Kanter). Any opinions, findings, conclusions, or recommendations expressed in this publication are those of the authors and do not necessarily reflect the views of the U. S. Department of Education.

**Study of Academic Instruction for Disadvantaged Students**

**ACADEMIC CHALLENGE FOR THE CHILDREN  
OF POVERTY**

**Summary Report**

**1992**

**Prepared by:**

**Michael S. Knapp, University of Washington  
Patrick M. Shields, SRI International  
Brenda J. Turnbull, Policy Studies Associates**

## Executive Summary

Schooling for the children of poverty has long been guided by a conception of curriculum and instruction that emphasizes basic skills, sequential curricula, and tight control of instruction by the teacher. Well executed, this approach to instruction has produced positive results on tests of basic skills, but when this is the primary or exclusive approach it may unnecessarily limit children's acquisition of advanced skills—the ability to reason mathematically, understand what is read, and compose written text that communicates effectively to others.

The results of this study in 140 classrooms across 15 schools demonstrate that alternatives to conventional practice in mathematics, reading, and writing instruction which place greater emphasis on meaning and understanding do indeed have something to offer the children of poverty. Across a variety of urban, suburban, and rural elementary schools serving high concentrations of children from low-income families we found that over a school year:

**By comparison with conventional practices, instruction that emphasizes meaning and understanding is more effective at inculcating advanced skills, is at least as effective at teaching basic skills, and engages children more extensively in academic learning.**

These results apply to schools that were chosen for better-than-average test score performance and are most clearly in evidence in fall-to-spring analyses (analyses across a 12-month period—such as fall of one year to fall of the next—show some evidence of these effects but are less consistent and conclusive).

This overall finding has several important implications for the design and conduct of instruction in elementary schools that serve high proportions of children from low-income families:

- **The findings dispel the myth that, for most of the children of poverty, academically challenging work in mathematics and literacy should be postponed until they are “ready”—that is, until they have acquired full mastery of basic skills.** Although such students are often lacking in certain basic skills, they can acquire these skills at the same time that they gain advanced skills (which provide a broader, more meaningful context for learning “the basics”).
- **Instructional practices aimed at meaning and understanding provide avenues for teachers to expand their repertoires.** Those who wish to do so can change their practices provided they receive the appropriate mix of encouragement, support, and flexibility. Those who aren't sure should be given sufficient exposure to alternative practices that they can make informed decisions about their value in the curriculum.

## Teaching for Meaning and Understanding

The instructional alternatives examined in this investigation have in common several characteristics: they emphasize meaning and understanding, embed the teaching of discrete skills in context, and draw connections between academic learning and students' home lives. Specifically, the following practices were the focus of study:

- **Mathematics:** Instruction that focuses on multiple mathematical topics and does so with emphasis on conceptual understanding and the application of mathematics to nonroutine problems as well as on skill building. This focus contrasts sharply with conventional practices aimed primarily at arithmetic computational skills.
- **Reading:** Instructional strategies aimed at maximizing comprehension—such as explicitly teaching comprehension strategies, integrating reading and writing, increasing the amount of time students read text, and providing children opportunities to discuss what they are reading. This emphasis contrasts with the conventional focus on discrete skills, comprehension at the literal level, reading in isolation from writing, and lack of attempt to make personal sense of what is read.
- **Writing:** Instruction that emphasizes writing composed, “extended” text (e.g., whole stories, poems, reports, or journals). Teachers who do so typically integrate reading and writing, teach the writing process, and teach language mechanics in context, by comparison with a more conventional focus on language mechanics out of context, no integration of writing and reading, little attention to the writing process, and “restricted” text writing (such as fill-in-the-blank exercises or short-answer worksheets) or even the absence of writing altogether.

These ways of teaching mathematics, reading, and writing demand a lot of teachers, and it was not surprising to find that few teachers in the study sample engaged extensively in alternative practices in all three subject areas, or even two of the three. More typically, teachers emphasized meaning and understanding in one or two subject areas while offering a more conventional form of instruction in others.

These alternatives are closely linked to the way teachers manage classrooms. Those teachers most engaged in alternative practices were likely to have orderly classrooms in which various types of activities and interactions among students and teachers were encouraged. (At the same time, these approaches to instruction were no guarantee of classroom order and engagement in instruction.) Essential to teaching this segment of the student population, the study found that:

**Teachers who emphasize meaning and understanding in their teaching are most likely to find ways of connecting instruction to students' home lives, thereby engaging students more successfully in academic learning.**

Supplemental instructional programs of various kinds (e.g., Chapter 1, ESL services, local programs) served most of the classrooms we studied. The contribution of these services to alternative instructional practices was mixed.

**Most of the supplemental services targeted to particular students provide extra practice in basic skills out of context; targeted supplemental instruction less often emphasizes meaning and understanding.**

The study found a considerable amount of targeted supplemental instruction delivered by aides in the classroom under the supervision of the regular classroom teacher; somewhat less frequently, instruction was delivered in pullout settings with varying degrees of connection to the regular classroom. Not all supplemental instruction was targeted to selected students, however. An alternative (though infrequent) use of special program funds was to support specialist teachers as instructional leaders in their buildings, offering team teaching, professional development, and new materials to extend the repertoires of classroom teachers.

## **Effects on Learning**

Using standardized tests and other measures (e.g., a writing sample and test of problem-solving proficiency), the study assembled evidence about the effects of these instructional practices on advanced and basic skills. Regarding **advanced skills**—reading comprehension, mathematical problem-solving proficiency, and competence at written composition—there was clear evidence that by comparison with students exposed to conventional instructional practices:

**Students extensively exposed to instruction emphasizing meaning and understanding perform better on tests of advanced academic skills at the end of the school year, even after initial differences in student achievement and poverty level are taken into account.**

Longer-term effects over a 12-month period were hard to assess given large-scale attrition of Year 1 students from the Year 2 sample. Fall-to-fall analyses provide some evidence in mathematics and writing that effects are retained over the summer months; from spring of one year to spring of the next, differences in writing and reading outcomes appear to persist.

Regarding **basic skills** (arithmetic computation, decoding, writing mechanically correct text), the study found that:

**Instruction emphasizing meaning and understanding often facilitates the mastery of basic skills, or at least does not impede it.**

The evidence regarding effects on basic skills was somewhat incomplete; not all grade levels or skill areas were tested, especially in reading.

Alternative instructional practices appear to work well for more than the most able students. In fact, on average, low-performing children (those in the lowest third of the achievement distribution at the beginning of the year) benefited at least as much as their high-performing counterparts (those in the top third of the achievement distribution).

## **The Environment for Academic Instruction in Schools, Districts, and States**

With a few exceptions, what teachers taught and how they taught it were influenced considerably by conditions and policies from outside the classroom. In schools, instructional leadership, curricular policies, and the management of external mandates affected teachers' approach to instruction. Districts exerted strong pressures on academic instruction through curriculum guidelines, textbook adoption choices, and testing. Although sometimes "buffered" or reinterpreted by school leadership, these pressures acted as a major stimulus to, or constraint on, the implementation of alternative instructional practices. More indirectly, state frameworks and assessment practices influenced teachers to pursue one or another approach to teaching.

As they interacted with each other, these conditions and policy actions encouraged or discouraged teaching for meaning and understanding through a combination of:

- **Pressures for change in instructional practice.** Depending on the curricular philosophy embodied in policy choices, schools, districts, and states could make it more or less likely that teachers would teach writing, emphasize geometry in their mathematics classes, or integrate reading with writing, to cite examples emerging from our findings.
- **Professional autonomy.** School leadership and district policies, in particular, left more or less room for teachers to try out instructional alternatives, for example, by experimenting with an integrated language arts approach that was unfamiliar to them or pursuing a mode of mathematics teaching that might not yield high test scores in the short term.
- **Support.** Teaching for meaning and understanding typically represented a considerable departure from the curriculum and teaching approach with which most teachers in our sample were familiar. Schools, districts, and states provided varying forms and degrees (from a moderate amount to virtually none) of support for these changes through professional development events, resource specialists or mentor teachers, and resources. Teachers who received ongoing advice, training, and resources were more likely to adapt their teaching.

### Implications for Action

Assuming that this nation wants students to attain mastery of advanced academic skills from the earliest grades, these findings have profound implications for educators and policy makers at all levels in the educational system.

- (1) **To support the expansion of teachers' instructional repertoires, local and state policy makers need to find an effective balance among pressure for change in instructional practice, permission for professional autonomy, and provision of support.** Curriculum mandates and associated tests will not, by themselves, "drive the system," although they are important. Teachers also need room to adopt new practices without feeling forced, and they need ongoing advice, training, and resources.
- (2) **Educators at all levels should resist the impulse to treat teaching for meaning and understanding as a formula for success.** The principles underlying these approaches to instruction cannot be mechanically applied to the classrooms serving the children of poverty. Teaching for meaning and understanding will represent an improvement in practice as teachers develop a deeper understanding of the subject areas they teach, adopt different goals, implement new instructional strategies, and find ways to connect subject learning with students' backgrounds. That result will come only with time, commitment, trial and error, and the support of school leaders.

Government agencies—at the federal and state levels—have various roles in the process of expanding teachers' repertoires. For example, they can promote and sustain the dialogue about these alternative practices, stimulate and support appropriate forms of professional development, and consider the various ways in which supplemental instruction can support teaching for meaning and understanding. Although indirect, their influence on classroom instruction can be both far-reaching and profound.



# Contents

	<u>Page</u>
<b>Executive Summary</b> .....	i
<b>Introduction</b> .....	1
The Study in Context .....	1
Study Questions .....	2
<b>Alternatives to Conventional Practice</b> .....	5
Teaching for Meaning and Understanding.....	5
Managing the Academic Learning Environment .....	11
Responding to Differences in Students' Backgrounds .....	14
Supplementing Instruction in the Regular Classroom .....	15
<b>Outcomes of Instruction That Emphasizes Meaning and Understanding</b> .....	19
Capacity to Understand, Reason, and Compose .....	19
Mastery of Basic Skills .....	25
Differences Between High- and Low-Performing Children .....	25
Other Influences on Outcomes.....	27
<b>The Environment for Academic Instruction in Schools, Districts, and States</b> .....	29
Explaining Differences Among Schools and Districts .....	29
Balancing Autonomy, Support, and Pressure for Change .....	34
<b>What the Study's Results Mean</b> .....	37
Identifying What Is Appropriate for the Children of Poverty.....	37
Expanding Teachers' Instructional Repertoires .....	38
Creating Supportive Conditions in Schools, Districts, and States .....	39
Reconsidering Governmental Roles in Academic Instruction for the Children of Poverty .....	40
Avoiding a Formula for the Future .....	42
<b>Acknowledgments</b> .....	45

## Exhibits

	<u>Page</u>
1 Conventional and Alternative Approaches to Mathematics, Reading, and Writing Instruction in the Sample Classrooms .....	6
2 Mathematics in a Third-Grade Classroom .....	7
3 Reading in a Fifth-Grade Classroom .....	8
4 Writing in a First-Grade Classroom .....	9
5 Likelihood of Adopting Alternative Practices in More than One Subject Area .....	10
6 A Dysfunctional Learning Environment and An Orderly, Enabling Learning Environment .....	12
7 Relationship Between Alternative Practices and Academic Learning Environments .....	13
8 Relationship Between Alternative Practices and the Extent to Which Teachers Connect Instruction to Students' Backgrounds .....	16
9 What Is Taught in Supplemental Instruction .....	18
10 Effects of Alternative Instructional Practices on Mastery of Advanced Skills in Mathematics Across the School Year .....	20
11 Effects of Alternative Instructional Practices on Mastery of Advanced Skills in Language Arts Across the School Year .....	21
12 Effects of Alternative Instructional Practices on Advanced Skills Over a 12-Month Period .....	23
13 Effects of Alternative Instructional Practices on Mastery of Basic Skills .....	26
14 Teachers' Engagement in Alternative Practices in Selected Schools within the Study Sample .....	30
15 Teachers' Engagement in Alternative Practices in the Six Districts within the Study Sample .....	31
16 Pressure for Change Without Adequate Support .....	32
17 A Successful Adoption of Alternative Practices in Language Arts Instruction .....	33

## Introduction

Educators and policy makers have long been concerned about the education of children from low-income families. That concern has come to a focus in recent years as reformers have drawn attention to issues of educational quality and the continuing inequities in schooling in America. In the view of many educators, the nation cannot afford to ignore questions regarding the quality of the academic instruction made available to economically “disadvantaged” children.

This report summarizes what has been learned from a major federal study of classrooms serving the children of poverty.\* The study explored the nature and effects of alternatives to conventional practices in mathematics, reading, and writing instruction in schools that serve high concentrations of children from low-income backgrounds.

In the remainder of this introduction, we sketch the study’s goals in the current reform context. In the next section, we identify and examine the principal alternatives to conventional practices in mathematics, reading, and writing instruction. Subsequent sections of the report detail what we learned about the effects of the alternatives on student learning; the school, district, and state context for academic instruction; and the larger meaning of study results.

### The Study In Context

For a generation, federal education policies have had the dual aim of expanding opportunities for special student populations and stimulating improvements in school quality. The commitment to educational opportunity is exemplified by programs such as Chapter 1 of Title I of the Elementary and Secondary Education Act, which funds supplementary services for “educationally deprived” students in schools with concentrations of children from low-income backgrounds. The focus on educational improvement has taken form most recently in the national educational goals and the AMERICA 2000 Initiative. An explicit part of this initiative is to create a new generation of schools that work for all children, incorporating all that is known about learning, pedagogy, and instructional technology.

Improving the access of children from low-income backgrounds to high-quality education raises the full range of issues on today’s professional and policy landscape. Strengthening students’ grasp of “advanced skills”—for example, their capacity to reason mathematically, read with full comprehension, and compose written text—is a case in point. As many reformers have pointed out, instruction

---

*The starting point for this study is the well-documented absence of instruction in advanced skills for the children of poverty.*

---

\* Readers wishing more detail about study findings and approach are referred to the full technical report by the same title. Volume 1 presents study findings in full; Volume 2 discusses the design and provides technical backup information.

aimed at these skills has been lacking in American education, and its absence has been especially noticeable in the learning diet of children from low-income families. National assessments and other research have documented this missing piece of the instructional program in schools that serve the children of poverty.

To inform a clearer understanding of the problems and possible solutions for such schools, the U.S. Department of Education called for an investigation of effective curriculum and instruction in schools that serve large numbers of children from low-income backgrounds. The Study of Academic Instruction for Disadvantaged Students offers one way to gain perspective on current and potential activities sponsored by the federal government. Rather than focus on a particular targeted program, as numerous other federal studies had done, this investigation focused on the entire academic program in the elementary grades, with attention to three core subject areas: mathematics, reading, and writing.

### **Study Questions**

The Academic Instruction Study addressed four primary questions regarding the content, conduct, and effects of instruction in schools serving high concentrations of children from low-income families:

- (1) How—and how much—does mathematics, reading, and writing instruction in schools serving the children of poverty reflect new research-based ideas about imparting advanced skills and challenging content?
- (2) How do teachers manage the academic learning environment and respond to differences in student background? How do special programs supplement instruction in the regular classroom to accommodate diverse student populations?
- (3) Which approaches to instruction in the three subject areas show promise for boosting students' mastery of advanced as well as basic skills? Do alternatives to conventional practice contribute as effectively to student learning as more traditional approaches?
- (4) What factors in the school, district, and state context support or inhibit the introduction of alternative instructional approaches?

---

The report answers these questions by describing and analyzing instructional practices in approximately 140 first-through sixth-grade classrooms located in 15 elementary schools that serve large numbers of children from low-income families. To increase the likelihood of identifying a variety of effective practices, schools within six different district settings across three states were chosen that had attained better-than-average performance on conventional measures of academic achievement. Within the schools, experienced teachers were selected at each grade level to represent variation in approach to mathematics, reading, and writing instruction.

## Alternatives to Conventional Practice

Recent research and a growing body of evidence from demonstration programs suggest that academically challenging learning experiences can benefit the children of poverty, who are at greatest risk of academic failure. In the typical elementary school, however, these students encounter instruction that is repetitive, uninspiring, and limited to “the basics.”

Current practice reflects, in part, a widely accepted “conventional wisdom” about the best ways to teach in such settings. These approaches emphasize curricula that proceed in a linear fashion from the “basics” to “advanced” skills (but seldom reach the latter), instruction that is tightly controlled by the teacher, and ability grouping that often becomes permanent tracks at an early age. “Good” instruction is that which keeps children at work on academic tasks. Children who fail to keep up are targeted for reteaching and extra practice with discrete skills, often through a supplemental instructional program. Although these approaches may improve children’s grasp of basic skills, they appear to shortchange the learning of more advanced skills in comprehension, reasoning, and composition.

In this section, we describe the alternatives to conventional practice that we encountered among the sample classrooms. Following that, we explore the relationship between these alternatives and the way teachers managed the academic learning environment and responded to differences in student backgrounds. Finally, we summarize what we have learned about the role of supplemental instruction in relation to these alternative patterns of instruction.

### Teaching for Meaning and Understanding

Rather than study any particular technique or instructional program, we focused on certain core features shared by a variety of approaches that depart in some fashion from conventional practice. As summarized in Exhibit 1, the alternative ways of teaching mathematics, reading, and writing we encountered had three principal features in common:

- *Emphasis on meaning and understanding.* Alternative approaches in each subject gave priority to understanding and meaning—for example, by helping students to comprehend what written text said “between the lines,” communicate in writing thoughts that an audience would care to know, or understand what mathematical procedures meant and how they could be used with unfamiliar problems.
- *Embedding skills in context.* In each subject area, alternative approaches deemphasized (but did not abandon) the teaching of discrete skills out of the context in which these skills were applied, that is, apart from their appearance in written text, in the act of composing, or in problems that could be solved with mathematical tools.

---

*Alternatives to conventional practice emphasize meaning and understanding, embed skills in context, and connect instruction to students’ lives outside of school.*

---

**Exhibit 1**

**Conventional and Alternative Approaches to Mathematics, Reading, and Writing Instruction in the Sample Classrooms**

**Practices that Follow "Conventional Wisdom" Most Closely**

**Practices that Depart the Most From Conventional Wisdom**

**Mathematics Instruction**

- |   |   |
|---|---|
| <ul style="list-style-type: none"><li>• Focus on arithmetic to the exclusion of other mathematical topics</li><li>• Primary or sole goal of teaching computational skills</li></ul> | <ul style="list-style-type: none"><li>• Focus on multiple mathematical topics</li><li>• Emphasis on conceptual understanding and applications in addition to skill building</li></ul> |
|---|---|

**Reading Instruction**

- |  |   |
|--|---|
| <ul style="list-style-type: none"><li>• Focus on reading mechanics taught out of context</li><li>• Little time for reading text</li><li>• Separation of reading from writing</li><li>• Little teaching of comprehension strategies or focus on comprehension beyond literal meaning</li><li>• Little or no attempt to discuss reading and extend knowledge</li></ul> | <ul style="list-style-type: none"><li>• Reading mechanics taught in context</li><li>• Extensive opportunities for reading text</li><li>• Integration of reading and writing</li><li>• Implicit teaching of comprehension and focus on deeper understanding of text</li><li>• Regular opportunities to discuss reading</li></ul> |
|--|---|

**Writing Instruction**

- |  |  |
|--|--|
| <ul style="list-style-type: none"><li>• Little or no writing of extended text</li><li>• Separation of reading from writing</li><li>• Emphasis on language mechanics skills taught out of context</li><li>• Little attempt to teach the process of writing</li><li>• Little or no interaction allowed among children in connection with writing</li></ul> | <ul style="list-style-type: none"><li>• Extensive writing of extended text</li><li>• Integration of reading and writing</li><li>• Language mechanics taught in context</li><li>• Explicit teaching of the writing process</li><li>• Interaction encouraged among children in connection with writing</li></ul> |
|--|--|

- *Connections between subject areas and between school and life outside of school.* Finally, in each subject area, alternative approaches stressed the connections between one subject area and the next and between what was learned in school and children's home lives.

The classrooms we studied varied in the degree to which they embraced these alternative principles. At one end of the continuum in each subject area, classrooms departed little or not at all from the conventional wisdom described above. In classrooms that departed the most from conventional practice, the curriculum, the nature of academic tasks, and teachers' ways of delivering instruction looked considerably different from the basic skills-oriented curriculum and direct teaching style that typified conventional classrooms.

The principles underlying alternative approaches to instruction mean somewhat different things in the three subject areas we studied. In mathematics, the hallmark of alternative practices was the range of mathematical topics other than arithmetic included in the curriculum and the degree of emphasis placed on conceptual understanding. Instruction in classrooms that departed the most from conventional practice, illustrated in Exhibit 2,\* comes close to the goals of current reform movements in mathematics reflected in the National Council of Teachers of Mathematics' *Curriculum and Evaluation Standards for*

---

*In mathematics, teachers who use alternative approaches cover many topics and emphasize conceptual understanding.*

---

## Exhibit 2

### Mathematics In a Third-Grade Classroom

The teacher appears to be doing an excellent job of implementing the relatively new state framework for mathematics education in a diverse inner-city third-grade classroom. Although she emphasizes arithmetic computation skills throughout the year, she also integrates instructional material relating to geometry, measurement, problem solving, logical reasoning, statistics and probability, and patterns and sequence. The teacher uses manipulatives to help teach concepts. Cooperative learning groups are often used in her class; in fact, about one-third of the class time is in some sense "student-directed," which is exceptionally rare. The teacher consistently makes connections between one mathematics concept and another, thereby helping to present mathematics as a unified discipline, not just a set of different skills.

\* This and subsequent exhibits illustrating classroom practices and environments are taken from our fieldwork. Names have been changed to maintain confidentiality.



*School Mathematics.* Such classrooms differ a great deal from instruction in which arithmetic computational skill is the overriding or sole focus.

---

*In reading, alternative strategies aim at full comprehension of written text.*

---

In reading, classrooms that departed the most from conventional practice adopted strategies aimed at maximizing children's understanding of what they read—for example, by increasing the amount of time children spent actually reading text, by explicitly teaching comprehension strategies, and by providing children opportunities to discuss what they were reading. In classrooms in which these strategies were most in evidence, as illustrated in Exhibit 3, reading instruction was typically part of an integrated language arts curriculum. In some cases, what teachers did was based on "whole language" philosophies, but few of the classrooms we studied would be considered exemplars of "whole language" teaching. Virtually all the reading teachers devoted a substantial amount of time to teaching reading mechanics skills in one way or another. The distinguishing features among classrooms were the other learning experiences students encountered in reading instruction, as well as the way in which skill learning was (or wasn't) connected to reading itself.

### Exhibit 3

#### Reading in a Fifth-Grade Classroom

In a multiracial fifth-grade classroom, the teacher has shifted from basal readers to a literature-based curriculum designed by her and a colleague. During reading instruction, she pushes her students to expand not only their vocabularies and knowledge of the world but also their ability to interpret what they read. For example, while reading two stories that center on the experiences of black Americans during the Revolutionary War, the class is assigned to write about fairness in the stories. Later, the students share the results of their efforts with each other. As the teacher guides the students in the presentation of their thoughts to peers, she teaches them how to compliment and support each other in a group setting. As the children read what they have written, the teacher finds something encouraging to say to each before offering constructive criticism and suggestions for expansion or rewriting. This teacher finds that having students write about what they have read facilitates comprehension. In addition, she reads aloud to her class extensively and regularly, and types and distributes song lyrics as a music-related activity.

---

*In writing, alternative approaches call on children to write a lot.*

---

In writing, the most important difference among classrooms had to do with the amount of composed "extended" text that children wrote in the classroom—that is, stories, reports, essays, or other forms of text that allowed children

to express their thoughts in an elaborated form, as contrasted with "restricted" text such as fill-in-the-blank exercises, copying, or short sentence answers to questions on a worksheet.

In classrooms that had a great deal of extended writing, illustrated in Exhibit 4, teachers tended to use a variety of instructional strategies that maximized students' opportunities for meaningful written communication. These strategies parallel those noted above for reading instruction and generally reflect the attempt to integrate the teaching of language arts. They depart considerably from conventional practice characterized by a focus on the mechanics of writing (spelling, grammar, punctuation rules, etc.) with relatively little practice in writing text.

#### Exhibit 4

##### Writing In a First-Grade Classroom

A visit to this inner-city first-grade classroom at any time during the year reveals the importance given to written text. The walls of the classroom are filled with word lists, poems, the class daily newspaper, and stories dictated to the teacher early in the year and later written by the students themselves. Each morning, the students dictate to the teacher five or six sentences that comprise that day's newspaper, which is posted throughout the day and taken home by a different student each day. In the early weeks of the school year, the students draw story pictures and label these pictures, using words from the lists displayed around the room. Later in the school year, the students write three- or four-sentence stories. Approximately 90 minutes of each morning is devoted to students' dictating different kinds of text to the teacher and to reading these lists and stories. There is additional time for journal writing every day.

Curiously, what teachers in our sample did in one subject area tells relatively little about what they did in another. Few teachers were engaged in instruction that departed substantially from conventional practices in more than one of the three subject areas. Whereas nearly three-fifths of the sample teachers emphasized meaning and understanding in at least *one* of the three subject areas, as shown in Exhibit 5, only 18 percent did so in two or more, and only 3 percent did so in all three. In effect, teachers specialized. It was not unusual to visit a classroom in which writing lessons were filled with extended text writing and associated learning experiences, to be followed by the most mundane forms of skills-oriented mathematics instruction. Conversely, classrooms in which multiple mathematics topics were taught with an emphasis on conceptual understanding were sometimes the same classrooms in which reading instruction

---

*Few teachers in our sample embraced alternative practices in more than one subject area.*

---

was filled with skills dittos and oral reading at the literal level only. There was simply too much to know for teachers to master difficult new ways of teaching in all areas of the curriculum. Extra effort in one subject area often left less energy—and even less classroom time—for other subject areas.

**Exhibit 5**

**Likelihood of Adopting Alternative Practices  
In More Than One Subject Area**

Percentage of teachers<sup>a</sup> adopting alternative practices<sup>b</sup> in one or more subject areas, two or more, and all three, respectively.

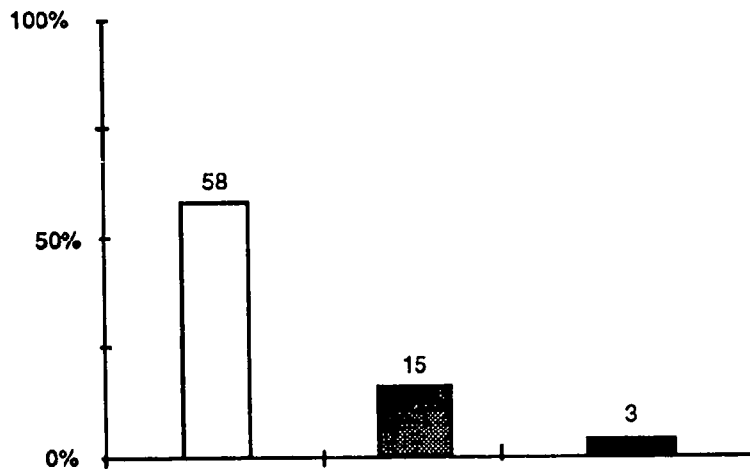

**Figure reads:** "Of the intensively studied classrooms in Year 1, 58% had adopted alternative practices in at least one subject area, as compared with 15% in two or more areas, and 3% in all three areas."

a - Based on analysis of the intensively studied classrooms in Year 1 (n = 40).

b - "Alternative practices" = (1) in mathematics, teaching multiple topics with emphasis on conceptual understanding; (2) in reading, extensively emphasizing comprehension-oriented instructional strategies; and (3) in writing, providing many opportunities for extended text writing.

**LEGEND**

Teachers adopting alternative practices in:

- One or more subject areas
- Two or more subject areas
- All three subject areas

## Managing the Academic Learning Environment

For the instructional strategies described above to be effective, students must be engaged in appropriate academic tasks. Teachers in schools serving the children of poverty typically find this to be a tall order, for reasons that include both the nature of the schools serving these children and the characteristics of the families and communities from which they come.

The teachers in the study sample had varying degrees of success in establishing and maintaining classroom order that sustains academic learning. Judged initially in terms of the consistency of student engagement in academic tasks, the teachers' efforts resulted in three distinct kinds of academic learning environments:

- *Dysfunctional learning environments*, characterized by a constant struggle to maintain order that overshadows attention to academic work. In such environments, relatively little sustained academic work takes place, as can be seen in Exhibit 6.
- *Adequate learning environments*, characterized by a basic level of control by the teacher, but with a continuing struggle over order. Some academic work takes place, but distractions are frequent.
- *Orderly learning environments*, characterized by an effective management system that results in keeping most or all students seriously engaged in academic work.

The majority of the teachers we studied fell into the third category, but a further distinction among them is important:

- *Orderly, restrictive learning environments*, found in smoothly run, highly structured classrooms, with tightly managed routines and a relatively narrow range of instructional strategies.
- *Orderly, enabling environments*, found in smoothly run classrooms with an often looser (though not loose) structure, and a wider range of routines and instructional strategies in evidence.

The latter group of classrooms, also illustrated in Exhibit 6, had a more comfortable feel to them and were characterized by a "spark" or enthusiasm for learning that the former lacked.

---

*Classroom management is inseparable from academic instruction.*

---

---

*Smoothly run classrooms can incorporate variety in instruction or can subtly restrict learning opportunities.*

---

## Exhibit 6

### A Dysfunctional Learning Environment

The students of various racial backgrounds in this fifth-grade classroom appear to like the teacher, but there is a constant tug of war between the teacher and the students over discipline. The teacher is quite stern with the students, yet she often allows them to socialize. They take advantage of every opportunity to interact with each other—whispering, calling out, passing notes, moving around. In cyclical fashion, the noise level slowly rises beyond what the teacher will tolerate. She then angrily warns the class to quiet down and eventually hands out individual punishments or makes everyone “write lines”—that is, fill several sheets of paper with a disciplinary sentence or the school’s mission statement. Things quiet down for a while, and the cycle begins again. Although they often seem eager to engage in learning activities, the students generally succeed in avoiding academic tasks entirely, especially when the tasks involve seatwork.

### An Orderly, Enabling Learning Environment

In a word, this teacher’s first-grade class in a rural area “hums.” It is a comfortable place where the children, half Hispanic and half Anglo, enjoy doing schoolwork; the business of learning is central to everything that is done in the room. Children treat each other and the teacher with respect, as a result of her careful lessons in how to listen to each other, to offer ideas verbally to the class, and to respect what others say. The teacher’s management style is calm and quiet. She is remarkably effective at maintaining order despite the fact that the classroom is one of four clustered together in a semi-open pod arrangement. She uses a combination of quiet reminders and individual praise for So-and-So, who is sitting nicely now. The result is that the students do what she asks the first time she asks, with rare exceptions (which are quickly brought into line), and attention is not drawn to management issues very often. The children devote nearly all of their energy to academic tasks and other aspects of the school’s curriculum.

Across these categories of classrooms, teachers displayed different basic management styles (e.g., how they dealt with disruptions, established classroom routines, or held students accountable for work) and choices about the subject matter they were teaching (e.g., how they motivated students in each subject area, paced instruction, or fostered student responsibility for learning).

Teachers’ management styles and choices about subject matter were closely linked to their decisions whether or not to emphasize meaning and understanding in one or more subject areas. As Exhibit 7 shows,

teachers who established “orderly, enabling” learning environments were the most likely to orient their instruction (in at least one subject area) toward meaning and understanding. (Such teachers did not change their approach to managing the learning environment in other subjects, however, even though their approach to the subject was more conventional.)

*Teachers who established “orderly, enabling” learning environments were most likely to teach for meaning and understanding.*

**Exhibit 7**

**Relationship Between Alternative Practices and Academic Learning Environments**

Among classrooms<sup>a</sup> with each type of learning environment, the percentage adopting an alternative approach to reading, writing, or mathematics instruction.<sup>b</sup>

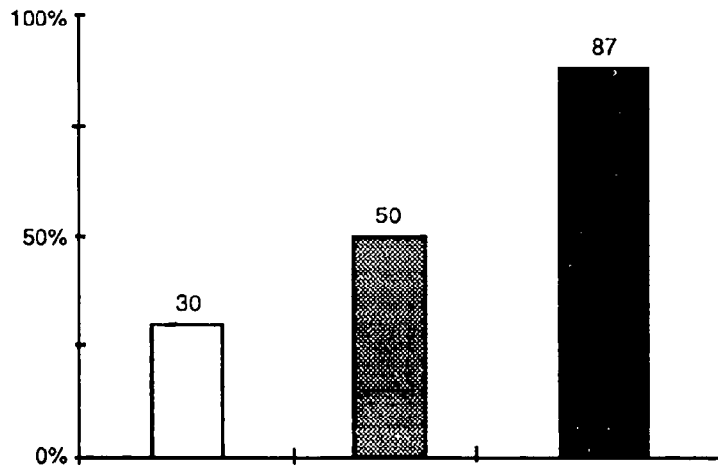

**Figure reads:** "Among classrooms with 'dysfunctional' or 'adequate' learning environments, 30% were engaged in alternative instructional practices, as compared with 50% of the classrooms with 'orderly, restrictive' environments and 87% of those with 'orderly, enabling' environments."

- a - Based on analysis of the intensively studied classrooms in Year 1 (n = 40).
- b - "Alternative practices" = (1) in mathematics, teaching multiple topics with emphasis on conceptual understanding; (2) in reading, emphasizing comprehension-oriented instructional strategies; and (3) in writing, providing many opportunities for extended text writing.

**LEGEND**  
 Type of academic learning environment:

- "Dysfunctional" or "Adequate" (n = 13)
- "Orderly, restrictive" (n = 12)
- "Orderly, enabling" (n = 15)

Though the nature of the academic learning environment in a classroom and the teacher's approach to a particular subject area are hard to separate, they are not one and the same. As the data in Exhibit 7 imply, some of the teachers in our sample who emphasized meaning and understanding in mathematics, reading, or writing did not manage to establish an orderly environment in which to learn. Conversely, some classrooms with orderly, enabling learning environments did not place high priority on meaning and understanding. In short, the instructional approach a teacher adopts does not guarantee a certain quality of learning environment.

### **Responding to Differences in Students' Backgrounds**

---

*Teachers who connected instruction to children's backgrounds engaged the children more successfully in learning.*

---

Reflecting the mix of cultures and social classes in the school attendance area, children in the classrooms we studied came from a variety of backgrounds. In some cases, the classroom was fairly homogeneous, as in the case of several all-white and all-black classrooms in which every child received a free or reduced-price lunch. More often, the classrooms were more diverse, combining children from poor and more affluent families and from two or more distinct cultural groups. In virtually all cases, the social and cultural (although not necessarily racial) backgrounds of most children in the classroom differed from that of the teacher.

The cultural and social diversity of the classroom presented teachers with a difficult task, which they approached in a variety of ways. Teachers' responses to this diversity ranged from approaches that actively excluded children from learning opportunities because of their backgrounds (e.g., in one classroom, not giving Hispanic children the chance to read aloud because they "might be embarrassed" in front of the Anglo children, who were generally better readers) to attempts to use students' backgrounds as a positive basis for learning in the classroom (e.g., in another classroom within the same district, choosing a novel about Hispanic migrant children as the centerpiece of a month's work in English and building a variety of learning experiences around this theme).

Our data indicate that the nature of a teacher's responses to student differences is clearly linked, first, to the teacher's decision to emphasize meaning and understanding in instruction, and second, to the degree of student engagement in learning. Teachers who took active, constructive steps to connect learning to students' backgrounds were much more likely to have chosen alternative approaches to teaching reading, writing, and

mathematics, as shown in Exhibit 8.\* This finding is not surprising; by focusing on understanding and meaning, teachers were building a bridge between children's knowledge base and the academic learning experience, which was unlike the home experiences of many students.

By connecting instruction more closely to children's home experiences, language arts teachers were also able to achieve higher levels of engagement in academic learning (the finding does not hold for mathematics, however; there, levels of engagement were approximately the same—and relatively high, on average—regardless of the extent of connection to students' backgrounds).

### Supplementing Instruction in the Regular Classroom

The contributions of supplemental programs (such as Chapter 1, special education, and various locally funded efforts) to the academic instruction offered the children of poverty are mixed and highly varied. In the study sample, each classroom presented a nearly unique configuration of supplemental services. Nonetheless, several overall observations can be made.

Supplemental instruction is a ubiquitous resource to the classroom teacher in the schools we studied. Children in nearly four-fifths of the sample classrooms received some form of supplemental instruction in language arts; half of the classrooms had some form of supplemental mathematics instruction. Almost two-fifths of the students in the study sample participated in one or more of these programs. More often than not, these services were offered within the regular classroom (chiefly by in-class instructional aides, but also by specialists in a quarter of all the language arts classrooms we studied). Approximately two-fifths of the classes had some form of supplemental instruction taking place outside the classroom, almost always taught by a specialist in a pullout room.

---

*Supplemental programs make an uneven contribution to instruction aimed at meaning and understanding.*

---

\* The exhibit displays the same basic pattern across both years, even though in Year 1 the range of variation on the connection variable was more limited. Thus, although in two subject areas during Year 1 no classrooms were coded as making extensive connections between instruction and students' backgrounds (hence, the letters "NA" for "data not available"), the relationship between making connections to students' backgrounds and engaging in alternative practices is still clear.



**Exhibit 8**

**Relationship Between Alternative Practices and the Extent to Which Teachers Connect Instruction to Students' Backgrounds**

Among classrooms with each degree of connection to students' backgrounds, the percentage of teachers engaged in alternative instructional practices.<sup>a</sup>

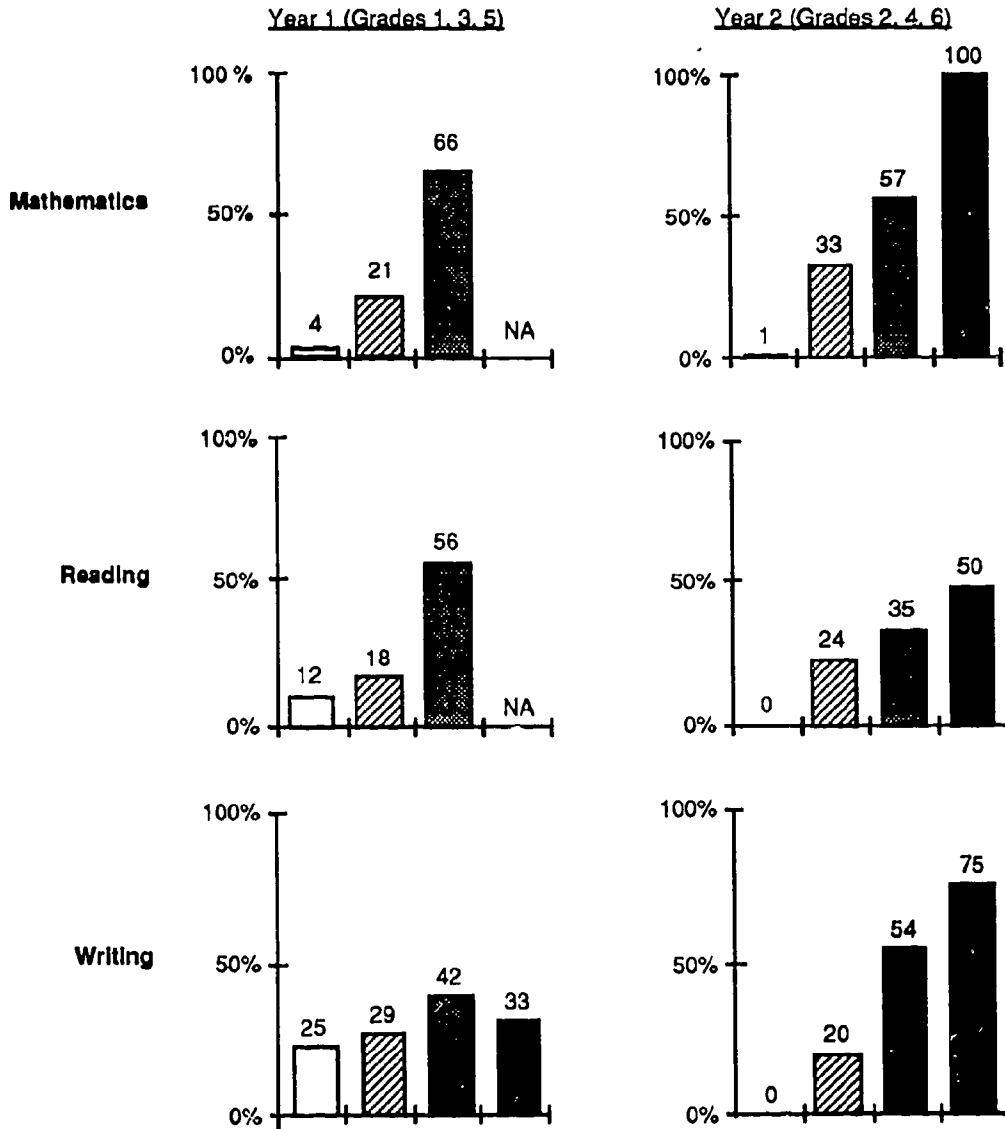

Figure reads: "In Year 1, among classrooms in which teachers make no connection with students' backgrounds, 4% are engaged in alternative instructional practices, as compared with 21% of those making some connections and 66% of those making a moderate number of connections...."

a - "Alternative practices" = (1) in mathematics, teaching multiple topics with emphasis on conceptual understanding; (2) in reading, emphasizing comprehension-oriented instructional strategies; and (3) in writing, providing many opportunities for extended text writing.

**LEGEND**

Extent to which teachers connect instruction to students' background:

- None
- ▨ Little
- ▤ Moderate
- Extensive

The most common role of supplemental instruction is to reinforce basic skills instruction. This is nearly universal in the reading and mathematics pullout rooms we observed, and is also the case in three-fourths of the in-class work, as shown in Exhibit 9. Other practices sometimes occur in supplemental classes; in half the observed mathematics pullout classes, for example, some attempt was made to get at conceptual understanding. The basic skills focus of most supplemental instruction reflects various factors, including the capabilities of supplemental staff and the belief held by some specialists in this focus of instruction. Our qualitative data suggest that a basic skills focus is especially common in Chapter 1 instruction, which in these schools typically aims to remedy children's specific skill deficits.

In some schools, however, supplemental instruction was at the forefront of the school's ventures into alternative practices. Here, the specialist teachers were sometimes important resources for the professional development of classroom teachers. They offered demonstration lessons, team teaching, and new materials that could extend the repertoires of those classroom teachers who were interested (Chapter 1 funding supported this approach in one district; local supplemental funding did so in two others).

Most supplemental dollars do not go into professional development or leadership, however, but into special help for selected students. For those targeted programs, including Chapter 1, the connections between supplemental and regular instruction vary with staffing decisions, scheduling, and intangible factors. We found a trade-off between the qualifications of program staff and the closeness of the relationship: instructional aides typically did what the classroom teacher asked them to do (although there were exceptions), while the specialist teachers might or might not synchronize their lessons with the classroom program or communicate with the regular teacher about students' progress. Schools sometimes facilitated communication through scheduling arrangements, but the match or mismatch in teachers' professional philosophies made a difference as well.

Whatever else it accomplishes, the presence of supplemental instruction creates or encourages different curricula for students of varying achievement levels. In most of the schools, what supplemental instruction does best is to sort students by their prior achievement and presumed potential, offering something different to those who do not quite measure up. Overall, the contribution of supplemental programs to instruction aimed at meaning and understanding appears to be uneven. To the extent schools favor the goals of this approach to instruction, there is a need to rethink how supplemental programs can make the greatest contribution.

---

*Supplemental instruction is often a bastion of basic skills. Sometimes, it supports efforts to teach for meaning and understanding.*

---

---

*What most supplemental instruction does best is sort students by their prior achievement.*

---

## Exhibit 9

### What Is Taught in Supplemental Instruction

Among classrooms<sup>a</sup> in which students participate in supplemental instruction, the percentage in which the supplemental program has each instructional focus.

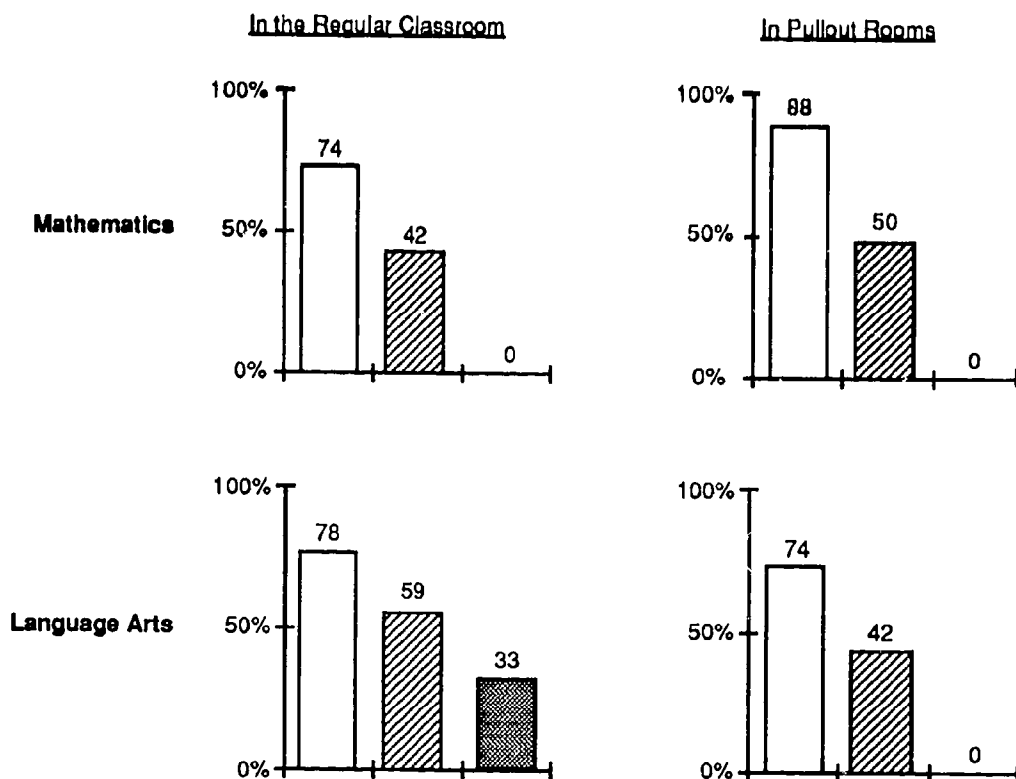

**Figure reads:** "Among classrooms in which students participate in supplemental mathematics within class, 74% had supplemental instruction aimed at practice with arithmetic computation, as compared with 42% in which supplemental instruction aimed at conceptual understanding and none aimed at application of math to nonroutine problems...."

**a -** Based on analysis of all classrooms in Year 2.

#### LEGEND

Focus of supplemental mathematics instruction:

- Arithmetic computation skills
- Conceptual understanding
- Applications to nonroutine problems

Focus of supplemental language arts instruction:

- Reading or language mechanics skills
- Reading text
- Writing composed text

## Outcomes of Instruction That Emphasizes Meaning and Understanding

The variation in approach to mathematics, reading, and writing instruction among the 140 classrooms we studied enabled us to examine the relative effectiveness of the different approaches, while controlling statistically for differences among classrooms that might influence outcomes. For simplicity in this summary report, we summarize the principal findings by contrasting classrooms placing the least emphasis on meaning and understanding (approximately a third of the sample for most analyses) with those that placed the most (between a quarter and a third for most analyses).

The study results answer questions of instructional effectiveness in four ways. First, for each year of the study, we assessed the relative associations between each type of instruction and measures of mathematical understanding, problem-solving ability, reading comprehension, and competence at written expression. Second, we carried out the same analyses across 12-month periods of time (e.g., fall to fall, spring to spring). Third, measures of mathematical computation, reading mechanics skills, and the mechanical correctness of written text provided a way of assessing the relative contribution of each classroom type to students' mastery of basic skills. Fourth, by comparing results separately for students in the lowest third of the overall achievement distribution with those in the highest third, it was possible to determine whether the associations between outcomes and instructional approaches depended on the students' initial levels of achievement.

### Capacity to Understand, Reason, and Compose

**Short-Term Outcomes (Fall to Spring).** There is evidence that students exposed to the instruction that emphasizes meaning and understanding in each subject area are likely to demonstrate a greater grasp of advanced skills at the end of the school year. As summarized in Exhibit 10, children receiving instruction that focused on multiple mathematical topics and conceptual understanding performed significantly higher in advanced mathematical skills [e.g., in Year 1 between 6 and 7 Normal Curve Equivalents (NCEs) higher on a standardized test of mathematical understanding] than their counterparts in classrooms in which conventional practice prevailed—that is, which focused on arithmetic skills only. \* Similar differences appear with regard to results on a test of mathematical problem-solving ability. The evidence was not so strong in the second year, though also in a positive direction. Exhibit 11 presents comparable results for reading comprehension and competence at written composition.

---

*At the end of the school year, students whose instruction has been aimed at meaning demonstrate a greater grasp of advanced skills.*

---

\* Normal Curve Equivalents (NCEs) provide a nationally normed score roughly comparable to percentiles, only with a more nearly linear scale. The lowest scores, approaching 0 NCEs, indicate a level of performance lower than nearly all other students nationwide; conversely, the highest scores, which approach 99 NCEs, demonstrate performance that exceeds nearly all other students in the nation.

Exhibit 10

Effects of Alternative Instructional Practices on  
Mastery of Advanced Skills in Mathematics Across the School Year

Difference in scores at the end of the school year, controlling for initial differences in achievement and poverty level--

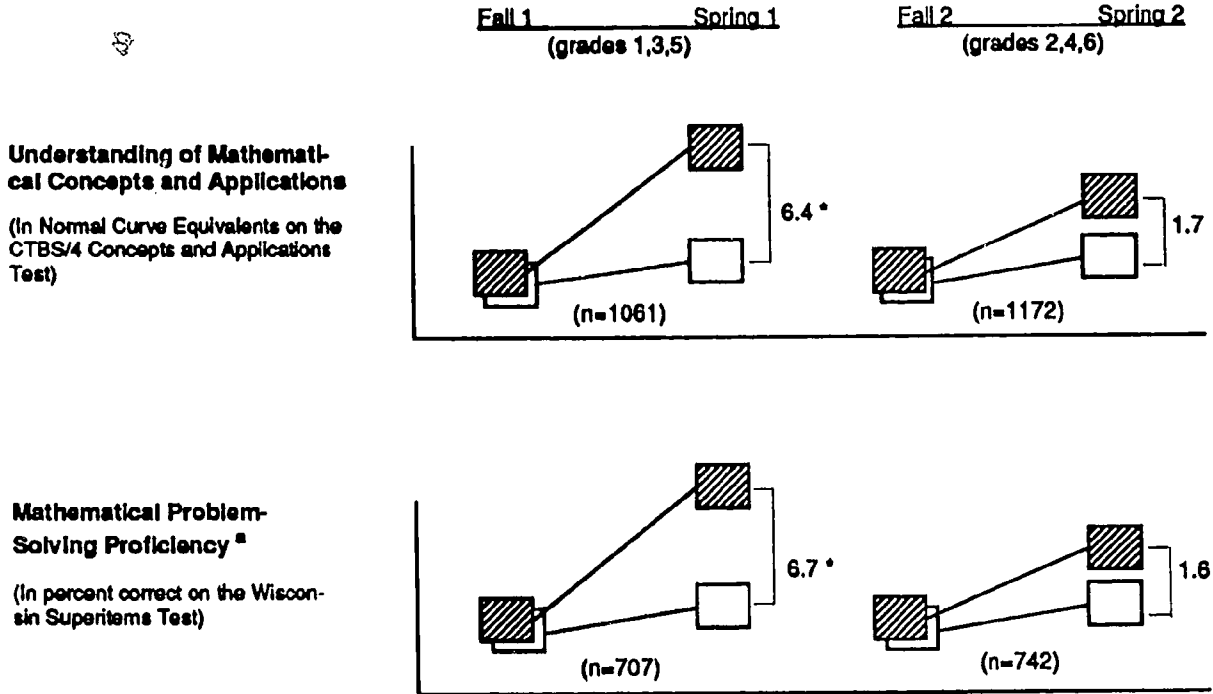

**Understanding of Mathematical Concepts and Applications**  
(In Normal Curve Equivalents on the CTBS/4 Concepts and Applications Test)

**Mathematical Problem-Solving Proficiency<sup>a</sup>**  
(In percent correct on the Wisconsin Superitems Test)

\* Statistically significant at  $p < .05$

Figure reads: "By comparison with their counterparts exposed to arithmetic skills only, students in classrooms exposed to multiple mathematical topics and with attention to conceptual understanding perform 6.4 NCEs higher at the end of Year 1, once initial differences in poverty level and achievement are taken into account. This result is statistically different from zero at the .05 level. . . ."

a - Grades 3-6 only

**LEGEND**

Students exposed to:



-  Conventional practice: Focus on arithmetic skills only
-  Alternative practice: Focus on multiple topics and conceptual understanding as well as skills

Exhibit 11

Effects of Alternative Instructional Practices on  
Mastery of Advanced Skills In Language Arts Across the School Year

Difference in scores at the end of the school year, controlling for initial differences in achievement and poverty level—



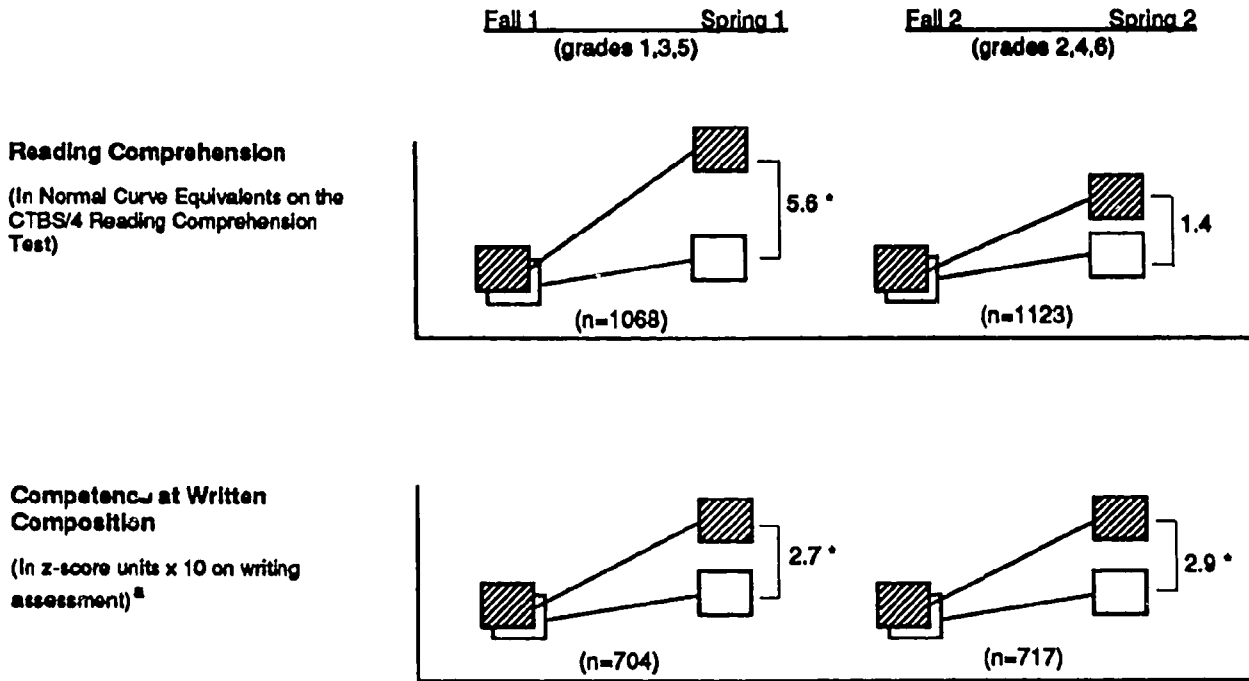

\* Statistically significant at  $p < .05$

Figure reads: "By comparison with their counterparts in classrooms with little comprehension-oriented instruction, students extensively exposed to these strategies perform 5.6 NCEs higher at the end of the school year, once initial differences in achievement and poverty level are taken into account. This result is statistically different from zero at the .05 level. . . ."

a - Grades 3-6 only

**LEGEND**

Students exposed to:

-  Conventional practice in reading (little focus on comprehension-oriented strategies) and writing (little or no writing of composed, extended text)
-  Alternative practice in reading (emphasis on comprehension-oriented strategies) and writing (a great deal of extended text writing)

The results appearing in these and subsequent figures represent the difference in learning outcomes at the end of each school year, controlling for initial differences in students' level of poverty and achievement. Put another way, the analysis identifies the increment of students' performance that can be attributed to the instructional approach, once initial differences among students are taken into account.\*

The results in writing are replicated across years in the study, whereas in mathematics and reading the effects are not equally strong in both years. There are various possible explanations for this fact, among them the uneven implementation of alternative forms of instruction in the second year (for example, when one controls statistically for differences in teachers' background or general proficiency at managing instruction, the end-of-the-year difference in mathematics outcomes shown in the figure increases and reaches statistical significance).

The results summarized in these figures mask some important differences between grade levels (although given the relatively small number of classrooms per grade, our ability to identify clear grade-by-grade differences is somewhat constrained). In mathematics, for example, effects of alternative forms of instruction on the mastery of advanced skills appeared to be less pronounced in the upper elementary grades.

#### **Longer-Term Results (Fall to Fall, Spring to Spring).**

The evidence regarding the retention of learning over a 12-month period (thus including the summer months) tells a similar story, although the results are slightly more mixed. Across the 12 months from fall to fall, students exposed to instruction aimed at meaning and understanding performed significantly better than their counterparts exposed to conventional instruction in two of the three subject areas (mathematics and writing), as shown in Exhibit 12. Parallel analyses across the 12 months from spring of the first year to the following spring reveal, in all three subject areas, positive differences that favor students exposed to instruction aimed at meaning and understanding, in one instance (writing) statistically significant and in another (reading) narrowly missing significance.

---

*Although the evidence is less strong, students exposed to instruction emphasizing meaning and understanding perform somewhat better at the end of 12 months (including summer).*

---

\* Readers should bear in mind that this study is not reporting average NCE gains from pretest to posttest, as is typically done in Chapter 1 evaluations. Instead, our NCE figures represent the differences between the posttest scores of students receiving different forms of instruction, controlling for differences in pretests and poverty level at the beginning of the year.

Exhibit 12

Effects of Alternative Instructional Practices on Advanced Skills Over a 12-Month Period

Difference in scores at the end of a 12-month period, controlling for initial differences in achievement and poverty level at the beginning of the period and for participation in a year-round school--

Fall 1 (grades 1,3,5)      Fall 2  
 Spring 1 (grades 2,4,6)      Spring 2

Understanding of Mathematical Concepts and Applications

(In Normal Curve Equivalents on the CTBS/4 Concepts and Applications Subtest)

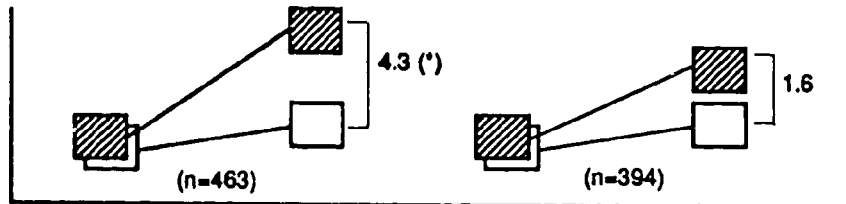

Reading Comprehension

(In Normal Curve Equivalents on the CTBS/4 Reading Comprehension Test)

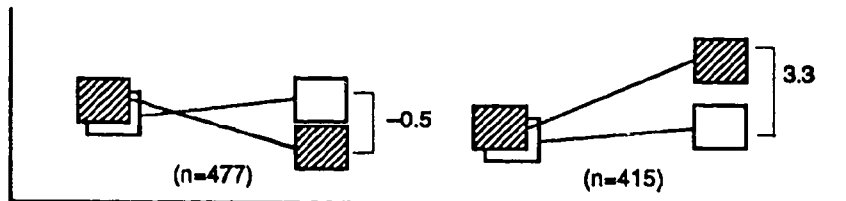

Competence at Written Composition

(In z-score units x 10 on writing assessment)<sup>a</sup>

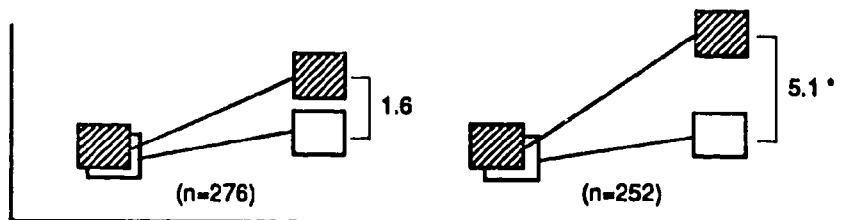

\* Statistically significant at p < .05 (\*) = p < .10

Figure reads: "By comparison with their counterparts exposed to arithmetic skills only, students in classrooms focusing on multiple topics and conceptual understanding score 4.3 NCEs higher after the 12-month period ending in Fall of Year 2, and 1.6 NCEs higher after the 12-month period ending in Spring of Year 2, once participation in a year-round school as well as initial differences in achievement and poverty level are taken into account. The first of these results is statistically different from zero at the .10 level; the second is not. . ."

a - Grades 3-6 only

**LEGEND**

Students exposed to:

- Conventional practices in mathematics, reading, or writing (see Exhibits 10 & 11)
- Alternative practices in mathematics, reading, or writing (see Exhibits 10 & 11)



These analyses must be viewed as somewhat inconclusive, however; findings across both 12-month periods are seriously hampered by possible attrition biases resulting from the loss of more than half the Year 1 students from the Year 2 sample.

The 12-month findings leave open the possibility that the results of instruction aimed at meaning and understanding are in various degrees susceptible to "summer fall-off." That fact does not negate the positive effects of such instruction across the school year, but it raises questions about the importance of additional educational support over the summer months and also about the value of continued exposure to alternative instructional practices across years. We were unable to explore the impact of sustained exposure to instruction aimed at meaning and understanding, because so few of the students from Year 1 who had experienced this kind of instruction ended up in classes the following year with comparable instructional experiences.

Because the size of effects is modest for most outcome analyses, it is worth asking whether the instructional approaches we have studied are helping the children of poverty very much. Our conclusion is that statistically significant group differences in the range of +1.4 to +6.4 NCEs are noteworthy and educationally important. In demonstration or experimental studies, considerably larger effects have been reported, but in such settings results can be demonstrated by experimental methods that permit a large number of relevant factors to be controlled. The results from this study are correlational: they indicate that when a variety of other relevant variables are taken into account, the instructional approaches we have been studying have positive associations with outcomes. They do so even when numerous other variables known to be related to learning (e.g., teacher expectations) are inconsistently or not at all linked to outcomes (see "Other Influences on Outcomes" below). The fact that instruction aimed at meaning and understanding has consistent effects in such circumstances strikes us as educationally significant.

## **Mastery of Basic Skills**

Outcome data for assessing the effects of instruction on children's grasp of basic skills are somewhat less complete than for investigating effects on understanding, reasoning, and composing skills: measures of basic skills attainment were available for only one of the two years in mathematics, only for children in the lower grades in reading, and in writing only for children in grades 3 - 6. Nonetheless, some patterns of association can be discerned in the available data, summarized in Exhibit 13.

Overall, there is evidence that alternative practices do not impede the mastery of basic skills and may facilitate it. In mathematics, children extensively exposed to alternative practices performed substantially better on measures of computational ability than students being taught arithmetic skills only—the very skills that were tested. In reading and writing, extensive exposure to instruction aimed at meaning and understanding generally produced positive differences in all but one instance (word attack skills in Year 1), although these differences were not statistically different from zero at the .05 level. At the least, children's learning of basic skills was no worse in classes that departed from conventional practices than in those that were oriented more toward curricula emphasizing basic skills learning.

In addition, analyses not shown in these figures indicated that a single-minded pursuit of basic skills instruction in writing through heavy doses of instruction in discrete language mechanics skills does not significantly improve students' grasp of *basic* skills. In reading, however, there is some evidence that such instruction does boost basic skills scores, at least in the early grades.

## **Differences Between High- and Low-Performing Children**

Alternative approaches to mathematics, reading, and writing instruction may not make so much sense in schools serving the children of poverty if they work well for only the brightest children in these schools. To discover whether this was the case, we divided the overall student population into thirds based on levels of achievement at the beginning of the school year and then ran parallel analyses for each third.

---

*Instruction aimed at meaning and understanding does not impede mastery of basic skills and may facilitate it.*

---

**Exhibit 13**

**Effects of Alternative Instructional Practices on Mastery of Basic Skills**

Difference in scores at the end of the school year, controlling for initial differences in achievement level and poverty—

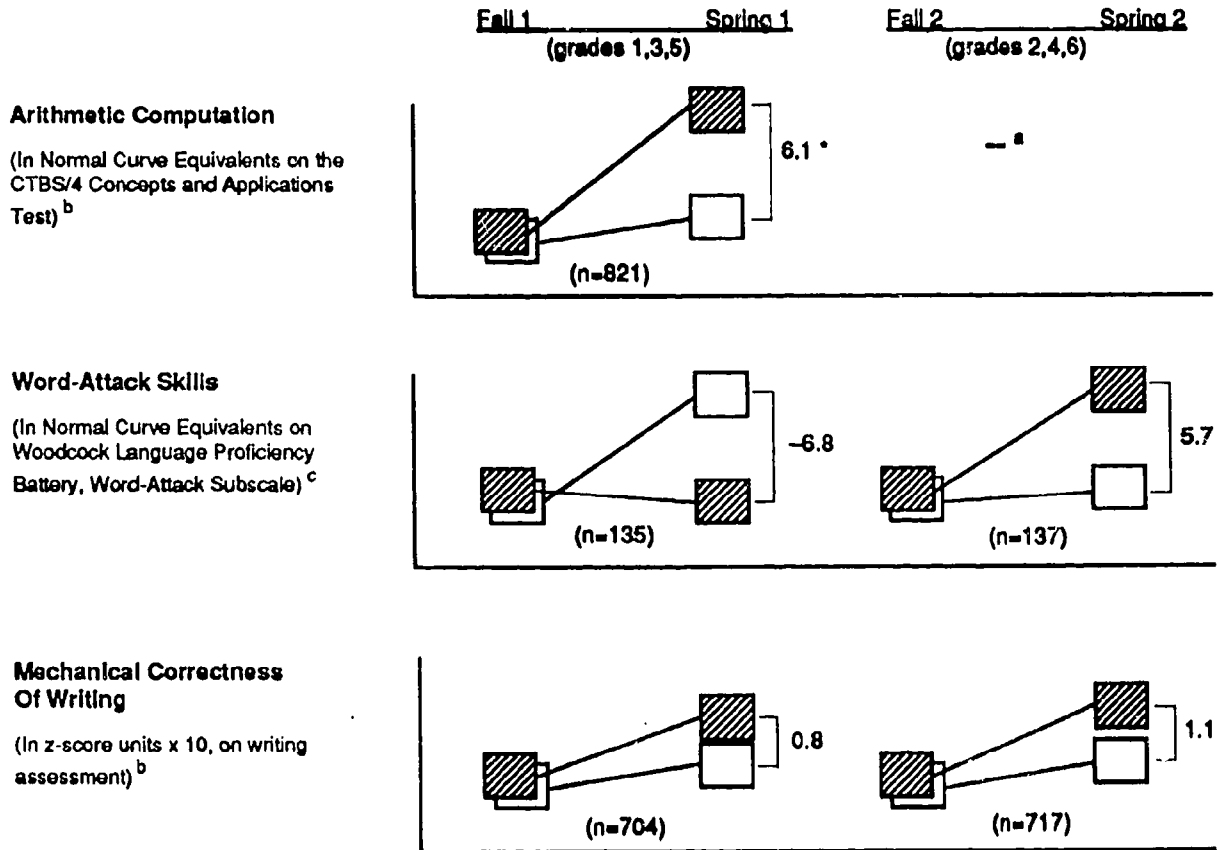

\* Statistically significant at  $p < .05$

Figure reads: "By comparison with their counterparts exposed to arithmetic skills only, students in classrooms emphasizing multiple topics and conceptual understanding score 6.1 NCEs higher at the end of Year 1, once initial differences in achievement and poverty level are taken into account. This result is statistically different from zero at the .05 level. . . ."

- a - Data unavailable in Year 2
- b - Grades 3-6 only
- c - Grades 1-2 only

**LEGEND**

Students exposed to:

- Conventional practices in mathematics, reading, or writing (see Exhibits 10 & 11)
- Alternative practices in mathematics, reading, or writing (see Exhibits 10 & 11)

The results present clear evidence that alternative practices work at least as well for low-performing as high-performing students. In all three subject areas, instruction aimed at meaning and understanding appeared to work as well for students at the low end as those at the high end of the achievement distribution. In both years, the incremental difference attributable to alternative practices is positive for both groups, and in half the instances it is statistically different from zero at the .05 level. The weight of evidence thus inclines toward the assertion that, on average, after initial differences among them are taken into account, low-performing children increase their grasp of advanced skills at least as much as their high-achieving counterparts when both experience instruction aimed at meaning and understanding. And for both groups, this approach to instruction produces results superior to those of conventional practices.

### Other Influences on Outcomes

We considered other factors that might influence results both because they might offer alternative explanations for the apparent effects described above and because they might provide important insights into the components of effective practice. We did so by running outcome analyses with additional variables in the equation—regarding instructional time, attention to discrete basic skills, the teacher's general proficiency at managing instruction, and other background characteristics of the teacher.

These analyses indicate that the association between approach to instruction and students' capacity to understand what they read, reason mathematically, and compose is largely unaffected by the presence of these variables in regression equations. In other words, it appears that the results we have described cannot be accounted for solely by the amount of time spent in instruction, the attention paid to discrete skills teaching, or various characteristics of the teachers. At the same time, many of these variables are themselves significantly linked to variation in outcomes and in directions one might expect. In particular, the amount of time spent in instruction is positively associated with outcomes, as is the teacher's general proficiency in managing instruction. Interestingly, the amount of instruction in basic skills (which alternative-approach teachers did in varying degrees) was also positively linked to advanced skill outcome scores.

Independent of instruction in any given year, characteristics of the students themselves are also consistent predictors of achievement outcomes. In all our analyses, two characteristics—poverty level and initial achievement level—are consistently and powerfully linked

---

*When both experience instruction aimed at meaning and understanding, low-achieving children benefit as much as their high-achieving counterparts.*

---

---

*Alternative practices exert an effect on learning over and above factors such as instructional time or the teacher's skill as a manager.*

---

to outcome scores (and, in statistical terms, they account for most of the variance in outcome measures). This result is hardly surprising; decades of educational research have uncovered similar associations. In other words, children's learning in a given year reflects the influence of various factors linked to poverty level (e.g., differential access to school resources, variable home support for learning, lack of familiarity with the culture of the school, inadequate nutrition) and achievement at the beginning of the year (e.g., the cumulative effect of inadequate teaching in earlier years, lower levels of innate ability, self-images of the learner from a low-income background, a developing pattern of resistance to the culture of the school).

## The Environment for Academic Instruction in Schools, Districts, and States

In light of the promise that teaching for meaning and understanding holds for the children of poverty, it is important to examine the conditions that support teachers' adoption of such new instructional techniques. With rare exceptions, we found that teachers in our sample were strongly influenced in what and how they taught by forces outside the classroom door. There are real differences across schools, districts, and states because conditions and policy choices at these levels enhance—or constrain—what teachers are able to do in the classroom.

We discuss below the major forces that explain instructional differences among schools and districts and implications for adoption of instruction that emphasizes meaning and understanding.

### Explaining Differences Among Schools and Districts

Exhibit 14 displays, for selected schools within the sample, the percentages of classrooms that were extensively engaged in alternative practices. As the exhibit demonstrates, there are big differences among schools. Take, for example, Schools 1 and 12: the two present nearly opposite profiles, with the former exhibiting high percentages of teachers engaged in alternative practices in all three subject areas and the latter with practically none so engaged. In between these extremes, schools often are characterized by a specialty subject, as in the case of School 3, which has made writing a major focus of its curriculum, or School 10, which houses a mathematics and science magnet program. These two schools show high percentages of teachers engaged in alternative practices in one subject (writing or mathematics) but not in the other two subject areas.

---

*Alternative practices have taken root in some schools and districts but not others.*

---

At the district level, too, differences in the aggregate profile of instructional practices show up, as illustrated by Exhibit 15. This is not to say that all schools within these districts are similar to one another. For example, the two schools in our sample from District 1 have nearly identical profiles with regard to reading and writing instruction but are nearly opposite in mathematics instruction.

Why do alternative practices in a particular subject area take root in some school settings but not in others? The answers include two sets of factors. The first reflects the demography of students and teachers. On average, classrooms with higher levels of poverty and larger classes are slightly less likely to have instruction that departs from the conventional wisdom (this fact may reflect a number of things, including the assignment of teachers to classes based on policy-level assumptions about what's "good" for certain types of classrooms). In addition, over time, certain schools may attract and retain teachers with compatible instructional philosophies.

**Exhibit 14**

**Teachers' Engagement In Alternative Practices  
In Selected Schools within the Study Sample**

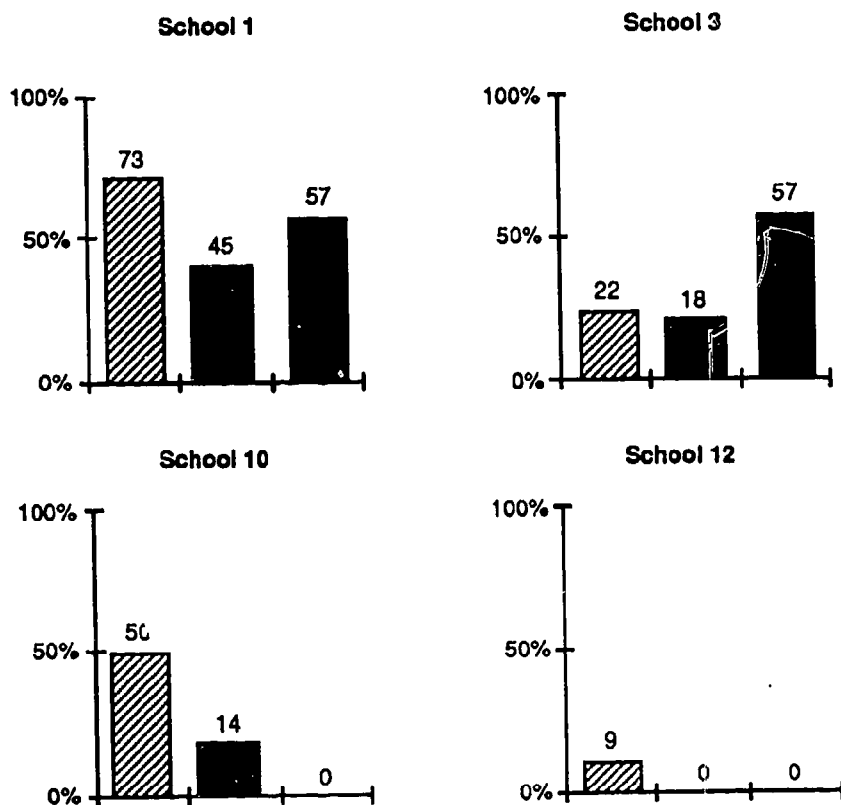

Of the sample classrooms<sup>a</sup> located in each school, the percentage engaged in alternative practices.



**Figure reads:** "In School 1, 73% of the sample classrooms were engaged in alternative instructional practices in mathematics, 45% in reading, and 57% in writing...."

a - Based on analysis of all sample classrooms across both years.

**LEGEND**

- Alternative practices in:
-  Mathematics (focus on multiple topics with emphasis on conceptual understanding)
  -  Reading (emphasis on comprehension-oriented instruction)
  -  Writing (emphasis on extended text writing)

**Exhibit 15**

**Teachers' Engagement in Alternative Practices  
in the Six Districts within the Study Sample**

Of all sample classrooms<sup>a</sup> within each district, the percentage engaged in alternative practices.

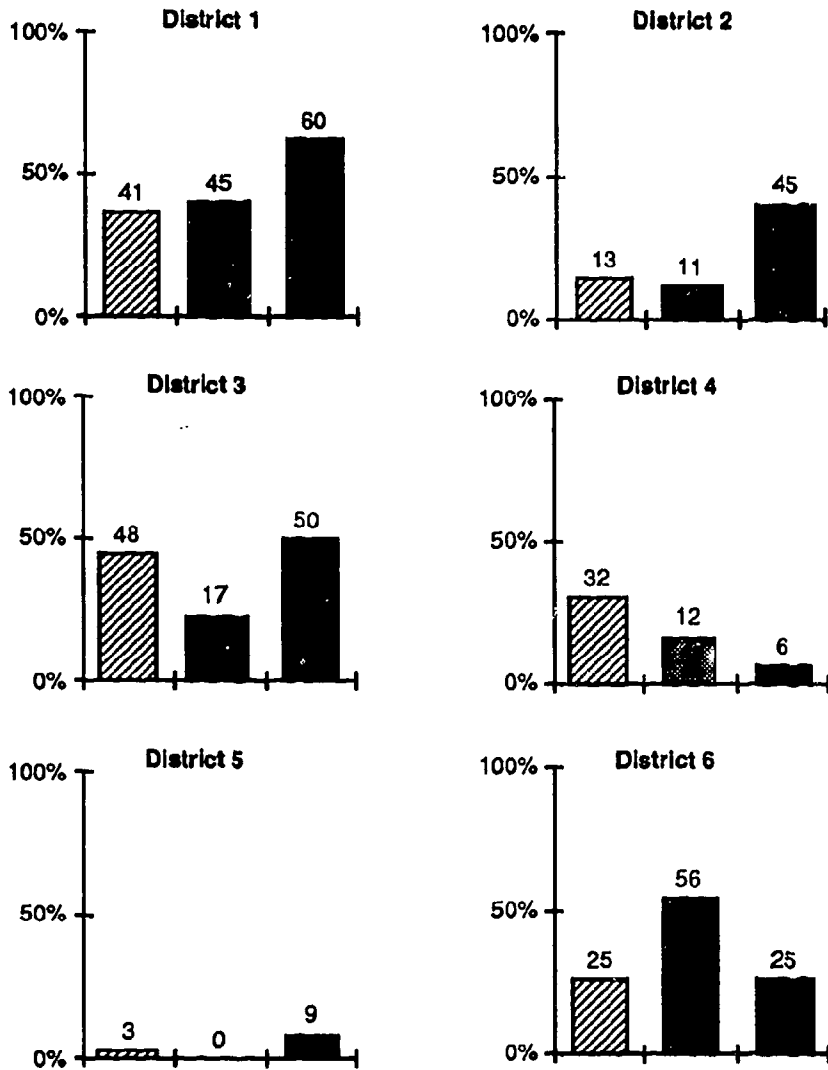





Figure reads: "In District 1, 41% of the sample classrooms were engaged in alternative instructional practices in mathematics, 45% in reading, and 60% in writing...."

a - Based on analysis of all sample classrooms across both years.

**LEGEND**

Alternative practices in:

-  Mathematics (focus on multiple topics with emphasis on conceptual understanding)
-  Reading (emphasis on comprehension-oriented instruction)
-  Writing (emphasis on extended text writing)



*Policy makers' choices influence teaching and learning in the classroom.*

The second set of factors stems from the interaction of school, district, and state policies. Policy makers' choices about appropriate teaching and learning and how to support them collectively affect an individual teacher's actions in the classroom. Sometimes, all these forces push a teacher in a single direction, as in the case of a new teacher who found herself in a district that placed very little emphasis on writing instruction and mandated the teaching of reading through a structured phonics-based program. Furthermore, the principal insisted on quiet, orderly classrooms. Although the teacher had been trained in integrated approaches to language arts instruction and started the year emphasizing active student learning, she eventually yielded to the pressures and altered her style of teaching to bring it more in line with conventional practices.

More typically in the classrooms we visited, policies were not so clearly aligned to support—or inhibit—particular practices. As in Exhibit 16, most teachers received mixed signals about what to teach.

#### Exhibit 16

##### Pressure for Change Without Adequate Support

Ms. Valencia has taught in the primary grades in an inner-city school serving a student population of mixed ethnicity for 6 years. Her own training in language arts emphasized a basic skills approach, with which she has become comfortable and which she believes produces good results with her pupils. In the last year, however, the district adopted a new, integrated language arts curriculum, virtually banned the use of ability grouping in reading, and requested that teachers introduce students to the writing process. At the beginning of the year, Ms. Valencia and her colleagues were introduced to the new curriculum in a 2-day training session, were handed new books, and were told by the principal to implement the new program.

Ms. Valencia's reaction—a combination of excitement, fear, and confusion—was typical of many teachers in the study who faced similar circumstances. Although attracted by the idea of the new language arts approach, she was very uncertain about how to put it into practice. For example, in one writing lesson we observed, she urged the students to focus less on sentence structure and spelling and more on communicating their ideas. As she walked around the room, however, she could not help pointing out grammar errors and even berated a child for writing ideas she felt had strayed too far from the meaning of the story. Ms. Valencia was sending her students a mixed message about writing because of her own uncertainty about the best way to teach it and her lack of training in new techniques. Moreover, both the district and state tests focused on spelling, punctuation, and grammar. Within this context, she tried to teach both ways.

The story of a teacher from a different school within the same district, presented in Exhibit 17, illustrates how teachers can develop new ways of teaching if school-based support reinforces a policy mandate.

### Exhibit 17

#### A Successful Adoption of Alternative Practices In Language Arts Instruction

Mr. Fulton has been a primary teacher for 5 years, during 2 of which he has taught third grade in his present school. Like Ms. Valencia, he had received training in language arts that emphasized skills-based instruction, and he too began the school year faced with the formidable task of taking on the new district-mandated language arts curriculum. However, Mr. Fulton's principal brought together the school's faculty on the first day of school, informed them of the district mandate, and made it clear that no one should feel pressure to implement the program more quickly than they felt prepared to do. Moreover, she appointed a committee composed of a reading specialist and two mentor teachers (all with extensive training in integrated approaches to language arts instruction) to lead the faculty through a review of the curriculum, to make recommendations, and to serve as resources to the other teachers.

Thus, Mr. Fulton began the school year feeling little pressure to make radical changes; in fact, he did not use the new curriculum at all for the first 6 weeks. As the year progressed, he incorporated more of the new program, spending less time on the skills-only teaching and more time providing students opportunities to write and manipulate extended text. At the same time, he retained several aspects of his former teaching approach (e.g., spending time each day reviewing phonics) because, in consultation with the reading specialist, he had decided his students could benefit from some skills-focused instruction.

The contrasting cases of Ms. Valencia and Mr. Fulton underscore the complexities involved in creating the conditions necessary for teachers to adopt alternative instructional approaches, especially when such approaches depart significantly from a teacher's own training and experience. These cases point to three areas of policy over which educational decision makers have control:

- *Pressure for change.* Neither Ms. Valencia nor Mr. Fulton would be likely to have adopted alternative practices in language arts in the absence of external pressures to do so. Both experienced such pressure because they teach in a district that has adopted a whole-language-oriented curriculum, reflecting in

---

*Policy makers foster alternative practices by creating pressure for change, permitting autonomy, and providing professional support.*

---

large part the emphasis of state curricular frameworks.

- *Professional autonomy.* The two cases differ markedly in the degree of professional autonomy the teachers were offered as they struggled to change the teaching approach. Mr. Fulton's principal buffered him from district mandates, encouraging him to implement the new program at a pace with which he felt comfortable and to the degree he thought appropriate for his students. In contrast, Ms. Valencia was simply handed the new curriculum and told to put it in place. Although she sometimes deviated from the new curriculum, she did so with fear that she would be discovered.
- *Professional support.* Similarly, Mr. Fulton received much more assistance in devising a new approach to language arts instruction. He had regular access to a reading specialist and two mentor teachers whom the principal had charged with the task of helping classroom teachers integrate the new program into their repertoires. Ms. Valencia received no such support. Her school's language arts specialist did not provide technical support for teachers but instead pulled students out of classes for extra help.

#### **Balancing Autonomy, Support, and Pressure for Change**

Adopting instructional strategies that emphasize meaning and understanding typically means that teachers must fundamentally rework their conceptions of the subject they are teaching and their approaches to it. Mandating changes without giving teachers considerable professional support and the flexibility to adapt the mandate to their particular circumstances can often be counterproductive. In such instances, many teachers become confused and embark on new approaches without understanding them, resulting in ineffective teaching.

As Mr. Fulton's and Ms. Valencia's cases make clear, the school is often the front line of support for teachers struggling to make changes. Principals, mentor teachers, and specialists can play an important role in encouraging certain instructional practices and providing guidance on how to adapt such practices to the particular circumstances of that school. Just as important, principals can buffer teachers from the demands of zealous state and district reforms, by providing teachers the freedom to experiment with practices that are new to them.

Districts can exert strong pressure on the academic program, through curriculum guidelines, textbook adoptions, and testing. We found that the district's

conception of "improvement" may favor or reject the premises underlying alternative practices. The power of district policies is illustrated by the virtual absence of teaching for meaning and understanding in District 5 (see Exhibit 15), where upgrading students' performance in basic skills has been an overriding policy aim.

Although more indirectly, state frameworks and assessment practices also influence classroom practice. Mr. Fulton's and Ms. Valencia's confrontation with a new language arts curriculum was initially set in motion by a new language arts framework and a concurrent change in state textbook adoption policies. The relatively high proportions of teachers adopting alternative practices in Districts 1, 2, and 3 reflect the fact that these districts are located in a state with a new framework and associated testing that encourage these instructional practices.

These two cases and the broader study findings suggest that policy makers have to find a balance between pressuring teachers to change their practice and providing sufficient professional autonomy and support to make that change meaningful and appropriate. We return to this theme in the next section as we discuss implications for action.

---

*To encourage teaching for meaning and understanding, policy makers must find the right balance among pressure for change, autonomy, and support.*

---

## What the Study's Results Mean

What do our results say about instruction that is effective for the children of poverty? Does adopting alternative approaches mean abandoning conventional modes of instruction, which, after all, have accomplished impressive gains in certain areas of learning? What do our findings imply for the roles of policy makers at the local, state, and federal levels who wish to establish and sustain more challenging instruction for the children of poverty? These are among the questions that call for reflection.

### Identifying What is Appropriate for the Children of Poverty

Because we have not examined comparatively the impact of instruction on students from affluent and low-income backgrounds, we have no empirical way to determine whether the practices we have been studying are uniquely suited to the children of poverty. But we can comment on the appropriateness of teaching for meaning and understanding for the segment of the population on which this study has concentrated.

Above all, our findings dispel one kind of myth that has been around for a long time regarding the children of poverty: that, because of their presumed or apparent deficiencies in relevant skills, academically challenging work should be postponed until they are "ready," that is, until they have mastered all relevant basic skills. Needless to say, the time of readiness never arrives for many children.

In fact, it is plausible that the alternative practices we have studied are *especially* appropriate for the children of poverty because, in cultural and social terms, they tend to live apart from the mainstream of American society. In the classrooms we studied, these practices help children connect their academic learning with the world they know outside the school, a world in which the routines, activities, and discoveries of the classroom often seem out of place. Alternative approaches to writing, for example, give children from these backgrounds numerous avenues of expression they would otherwise be denied. Strategies aimed at maximizing understanding in reading encourage children to get behind the literal meaning of words to deeper understandings. These are important opportunities for disenfranchised groups—there is much in their world that is hard to make sense of. The more chances and tools they have to do so, the better.

---

*The children of poverty need not master every basic skill before engaging in challenging academic work.*

---

## Expanding Teachers' Instructional Repertoires

---

*The study's results suggest that teachers need to expand their repertoires rather than to abandon familiar practices.*

---

Although instruction aimed at meaning and understanding reflects a rejection of many conventional premises for instruction, teachers in the study sample did not typically view themselves as choosing between incompatible pedagogical philosophies. More often than not, teachers combined conventional modes of instruction with alternative practices. For example, many teachers who taught multiple mathematical topics with emphasis on conceptual understanding also gave students considerable practice in arithmetic computation. Reading teachers typically taught reading mechanics alongside activities that maximized understanding.

In part, this tendency to combine old with new reflects teachers' learning curve: it is easier to learn new approaches by incrementally adjusting or adding to an existing repertoire than to start afresh with a whole new set of instructional routines. But the pattern may also reflect a sensible approach to the student population under study. Even though it is clearly effective to have students do a lot of reading with a focus on comprehension, the need for practice with decoding does not disappear. Alternative approaches to reading stress the need to encounter, learn, and practice decoding in context—and we observed a great deal of this in the classrooms we studied. But given that many students in this population have clear weaknesses in basic reading skills, there still may be an important role for additional practice in decoding done the “old-fashioned” way. Our findings about discrete skills teaching in reading are especially suggestive of this need.

Instruction that emphasizes meaning and understanding does call into question many assumptions underlying the conventional practice—regarding the place of “basic skills” in the overall curricular sequence, the usefulness of focusing on complex tasks (writing, reading, unfamiliar mathematics problems) from early on, and so on. But the bottom line for the children of poverty may be that instruction which appropriately *subsumes* conventional practices within an instructional framework guided by alternative assumptions has the most to offer. Thus, the prospect for teachers is not to abandon what they have been doing—and often doing exceedingly well—but to expand their repertoires to teach a more challenging curriculum.

---

*Attempting to teach for meaning and understanding does not guarantee “better” teaching.*

---

But expanding instructional repertoires is no guarantee of “better” teaching. It may seem from the study findings that basing instruction on alternative premises would lead teachers naturally to a mode of teaching that works better, in terms of the teachers' comfort level, students' engagement in academic learning, and the outcomes of instruction. However, our data make it clear that

instruction aimed at meaning and understanding was implemented well in some instances and poorly in others. Thus, we saw numerous instances of “bad” alternative teaching across the 2 years of the study. In extreme cases, teachers lost control of their classrooms in search of a more flexible structure, greater student responsibility for learning, more opportunities for expression, or flexible grouping arrangements. For example, of the 23 intensively studied classrooms in Year 1 that engaged extensively in alternative practices for one or more subject areas, 4 had serious problems with basic levels of classroom order, and 2 were classified as “dysfunctional.” (Of course, problems of classroom order were not unique to this group—two classrooms that taught all subjects in the most conventional way were also classified “dysfunctional.”) More frequently, teachers attempting to put alternative principles into practice “got the words but not the tune”—that is, undertook new kinds of learning activities without understanding them or exploiting their opportunities for learning. Many, perhaps most, of the teachers categorized as “moderately” engaged in alternative practices taught their classes this way. Such teachers might ask probing comprehension questions to get at deeper meanings of a reading passage, while neglecting to listen, probe, or respond to students’ answers. Or they might use manipulatives, ostensibly to motivate students’ learning arithmetic, without helping them make important conceptual connections (or even understanding the connections themselves). In writing instruction, extended composition tasks might be assigned or completed without any attempt at revision or even the realization by students that revision is part of writing.

Partial implementation of new practices is understandable as teachers struggle to master new ways of conceiving of the material they teach and of orchestrating children’s engagement with material. However, when many teachers think they fully understand alternative practices but grasp only part of the story, they may unintentionally defeat the very purpose they are trying to accomplish. Gaining a fuller appreciation of these practices requires sustained professional support, as noted below in the discussion of conditions surrounding the classroom.

### **Creating Supportive Conditions in Schools, Districts, and States**

If teachers are to expand their repertoires successfully, there is much that schools, districts, and states need to do. As noted above, the results suggest that a delicate balance must be struck among professional support, autonomy, and pressure for change in practice. No one of these elements by itself is sufficient to create a fully supportive

---

*Schools, districts, and states can do much to encourage and support teaching for meaning.*

---

environment. It is obvious from our data, for example, that pressure for improvement from school instructional leaders, district policy makers, and state agency officials helped to encourage—sometimes, push—teachers to try new ways of teaching mathematics, reading, or writing. At the same time, mandates without considerable professional support were not particularly effective (as in District 4) or, worse, were counterproductive in the sense that some teachers embarked on an alternative instructional approach without understanding what they were doing and then simply assumed that they had mastered it.

Similarly, teachers need enough autonomy to experiment, but full autonomy over their instructional programs will not necessarily lead teachers to expand their repertoires successfully. Left to their own devices, a smaller percentage of the teachers in our sample would most likely have tried to incorporate alternative instructional approaches into their existing routines.

In the final analysis, the study team has no easy solutions to suggest for state and local policy makers interested in changing the process of teaching and learning in elementary classrooms. However, we conclude that local and state policy makers can play key leadership roles in establishing clear goals, devising instructional strategies that are consistent with these goals, and providing resources or support to put these strategies in place. Importantly, such leadership and support must be combined with respect for the professional autonomy of teachers and school administrators, who ultimately will control what children are taught and how they are taught.

### **Reconsidering Governmental Roles In Academic Instruction for the Children of Poverty**

Besides what has just been discussed, state—and especially the federal—governments have various ways of influencing educational practice that are profound and far-reaching, although the policy instruments available are indirect. For example, government officials can exercise leadership in the national dialogue about education, and government programs can build capacity for understanding and addressing educational problems.

In the area of leadership, a major trend on the national policy scene that is consistent with the message of this report is the move toward ambitious standards of achievement for all students. For example, the AMERICA 2000 plan now advocates “world class” standards in academic subjects. Similarly, the National Council on Educational Standards and Testing urges the development of national curriculum standards and tests that would depart

---

*State and federal policy makers have options for promoting dialogue about alternative practices, supporting professional development, and reconfiguring supplemental programs.*

---



dramatically from the current *de facto* national minimum expectations for students. The Council's report argues that policy makers have done inadvertent harm to education by holding schools accountable only for students' mastery of basic skills—encouraging systems of curriculum and instruction that correspond to what we now call the conventional wisdom. The high standards now gaining endorsement by national policy makers would instead hold out much higher aspirations for schools, focusing to a greater degree on students' skills in conceptual understanding and reasoning.

To help build schools' and teachers' capacity to meet these high standards, federal and state governments have various options to consider. Among these options are identifying and disseminating new images of what can be done in classrooms. Our study is one example of projects that could be designed to investigate effective instruction that departs from the conventional wisdom. Conferences and networking activities of various kinds can address a similar goal. Such projects can challenge the assumption that alternative practices are best suited to children from privileged backgrounds or children who show unusual promise. Indeed, much research and development on the education of "gifted" children might usefully be replicated with more diverse populations; we suspect that the results might show that an "enriched" curriculum works for all students.

In addition to drawing attention to promising alternatives for instructional practice, government programs can stimulate and reshape professional development. This does not necessarily require new outlays of funds, since many programs already support professional development. For example, some small federal programs, such as the Eisenhower Mathematics and Science Education Program, have teachers' professional development as their chief aim; various state programs have similar goals. Even programs that do not target professional development as a primary purpose support various forms of staff development, organized by participating school districts. Technical assistance networks are another potential resource in this regard. Chapter 1, for example, supports federal contractors and state educational agencies to provide technical assistance, including assistance to teachers.

In this study, we found a few examples of supplemental programs (usually local programs rather than federal or state ones) supporting leadership in academic innovation within school buildings: some supplemental teachers were an important resource to their colleagues, making new materials available and modeling new teaching approaches in demonstration lessons. If they consider it a worthwhile use of program funds, federal or state program managers

can publicize and encourage this kind of communication and collegial support among teachers.

---

*Supplemental programs can offer instructional leadership, not just remediation for students' apparent skill deficits.*

---

Finally, for decades, state and federal governments have influenced the capacities of schools and classrooms by providing supplemental resources for the education of targeted groups of students. As this study shows, this policy tradition is reflected in schools that have become adept at sorting students by their apparent deficits. The effects on instruction are mixed at best. In the schools we visited, supplemental programs—notably Chapter 1—are often bastions of the sequential, skill-based instruction associated with conventional practices. This is not the outcome sought by many policy makers; the current Chapter 1 legislation, for example, emphasizes “more advanced skills” for students and mandates coordination between Chapter 1 instruction and the regular classroom program. The persistence of conventional program designs in these schools suggests that reconfiguring supplemental instruction remains a challenging policy goal.

#### **Avoiding a Formula for the Future**

---

*Instruction aimed at meaning and understanding has proved its worth.*

---

Our overall conclusion is this: instruction that emphasizes meaning and understanding, as interpreted and implemented by the teachers we studied, has proved its worth. Across a wide range of settings—and even in the absence of sustained support or focused promotion—these ways of conducting academic instruction have shown that they belong in the repertoire of teachers working with this segment of the student population. As such, they deserve the support of policy makers and curriculum designers responsible for the schools that serve the children of poverty.

The evidence favoring these approaches to instruction is not without important qualifications:

- *Our results come from a search for effective practice in better-than-average schools.* The conditions in “typical” or below-average schools serving children from low-income families may present less hospitable environments for the development of these approaches.
- *The clearest evidence about the outcomes of alternative approaches comes from fall-to-spring analyses.* There is some evidence regarding longer-term effects over a 12-month period but it is less strong and possibly is influenced by sizable attrition biases across years in our sample.

- *Alternative approaches (sometimes in conjunction with more conventional teaching) appear to contribute to the mastery of basic skills in most cases, but not all.* The main exception in our data is reading among lower elementary-age children (our data on mastery of basic skills are less complete than we would like). To the extent that educators believe in the value of demonstrated proficiency with basic skills, then, they may wish to be cautious about abandoning instruction that contributes most directly to these skills.
- *Alternative approaches demand a lot from teachers; not all teachers will want, or feel prepared, to engage in these practices.* Policy makers and those who support instruction should realize how much is required to make instruction of this sort work, plan support systems accordingly, and carefully consider the implications of policies that impinge on curriculum and instruction.

Given these qualifications and given all that is involved in according meaning and understanding a more central place in academic instruction for the children of poverty, educators should resist making teaching for meaning and understanding the formula for the future. There is nothing formulaic about the way the most successful teachers in this study approached their task. No checklist of behaviors, questioning styles, instructional strategies, or ways of connecting instruction to students' backgrounds exists—or could exist—that would bring teachers closer to the goal of offering the children of poverty an academically challenging learning experience in elementary school. This study's results are best thought of as a series of challenges to often unquestioned assumptions. As long as educators continually challenge these (and future) assumptions underlying their craft, the children of poverty will be well served.

---

*Teaching for meaning and understanding is not a formula but a continuing challenge.*

---

## **Acknowledgments**

This study report represents the product of many people's effort, commitment, and professionalism. We would first like to acknowledge the other authors of the full technical report (under the same title): Nancy Adelman, Camille Marder, Heather McCollum, Margaret Needels, and Andrew Zucker. The ideas presented in this summary report are a synthesis of their work as well as our own and represent the culmination of a productive collaboration over 3 years.

We are equally indebted to the other members of the field staff, whose data collection in classrooms and schools over 2 years provided both the raw material and many of the insights reflected in the analyses we have summarized: Lee Anderson, Rebecca Benjamin, Carol Carlson, Norma Francisco, Janie Funkhouser, Grace Pung Guthrie, Susan King, Gary Lichtenstein, Beverly Matson, Ellen McIntyre, Laverne Middleton, Christine Padilla, Christene Petry, Beverly Pringle, Katherine Ramage, Ellen Renneker, Lisa Richardson, Debra Shaver, Deborah Swanson-Owens, and Choya Wilson.

Other members of the SRI and PSA study team carried out the complex technical and logistical work of managing databases, programming, coordinating testing, and other administrative tasks too numerous to mention: Marion Collins, Carolyn Estey, Katherine Habina, Klaus Krause, Lucy Omo, Dorothy Stewart, Peggy Thompson, and Cynthia Williamson.

Various individuals offered advice and consultation on the study design and technical details of analysis and interpretation: Richard Allington, Beatrice Birman, Dale Boatwright, Jere Brophy, Gary Echnacht, Carolyn Evertson, Marcia Farr, Beverly Glenn, Bruce Henderson, Edward Haertel, Martin Orland, Andrew Porter, Marilyn Rauth, Robert Slavin, and Marshall Smith.

Though too many to name, we are most deeply indebted to the 140 teachers in California, Ohio, and Maryland who permitted us to observe their classrooms on repeated occasions, gave freely of their experience in interviews, and filled out daily classroom logs across an entire school year. To the principals and other staff in their schools and to the district staff who made the study possible, we extend our thanks.

Many others have assisted in small ways, among them various faculty and staff of the College of Education at the University of Washington. In addition, the College's Education Leadership and Policy Studies Area deserves special mention for its generous contribution of faculty time and other resources to help bring this study to completion.

Finally, we wish to thank the members of the Office of Policy and Planning, the Office of Compensatory Education, and other offices within the U.S. Department of Education, whose vision and continuing support made this investigation possible.

Michael S. Knapp, University of Washington  
Patrick M. Shields, SRI International  
Brenda J. Turnbull, Policy Studies Associates

March 1992

## Other Volumes of This Report

### *Volume 1: Findings and Conclusions*

#### **Overview and Introduction**

- Summary and Conclusions
- I Study Focus and Approach
- II Schools, Districts, and Classrooms Serving the Children of Poverty

#### **Part One: Mathematics Instruction**

- III Mathematics Curriculum and Instruction in Sample Classrooms
- IV Alternative Approaches to Curriculum and Instruction in Mathematics
- V What Children Learn from Different Types of Mathematics Instruction

#### **Part Two: Reading Instruction**

- VI Reading Curriculum and Instruction in Grades One through Six
- VII Alternative Approaches to Curriculum and Instruction in Reading
- VIII What Children Learn from Different Approaches to Reading Instruction

#### **Part Three: Writing Instruction**

- IX Writing Curriculum and Instruction in Grades One through Six
- X Alternative Approaches to Writing Instruction
- XI What Children Learn from Different Approaches to Writing Instruction

#### **Part Four: Cross-Cutting Considerations**

- XII Managing Academic Learning Environments
- XIII Making Academic Instruction Work for Children from Different Backgrounds
- XIV Supplementing Instruction in the Regular Program

#### **Part Five: Students, Teachers, and School Settings as Influences on Academic Instruction**

- XV Student and Teacher Characteristics That Shape Academic Instruction
- XVI The School, District, and State Environment for Academic Instruction

### *Volume 2: Study Design and Technical Notes*

This volume contains chapters that describe the study design, assess its potential for further research application, describe measures used in all analyses, and discuss the approach to analysis. Appendices include instrumentation and tables presenting full regression results for all outcome analyses.

These volumes may be obtained by contacting:

U.S. Department of Education  
Office of Policy and Planning (Planning and Evaluation Service), Room 3127  
400 Maryland Ave., S.W., Washington DC 20202